

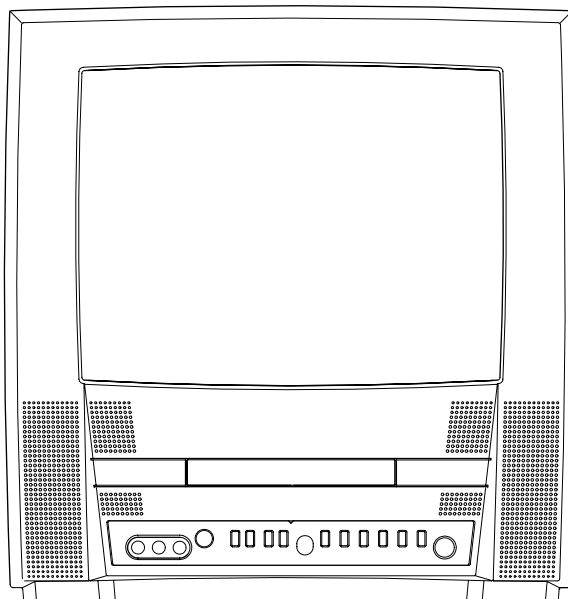

OWNER'S MANUAL

SYLVANIA

COLOR TV/DVD **6513DE** (13 inch)



**INSTRUCCIONES
EN ESPAÑOL INCLUIDAS.**

 As an ENERGY STAR® Partner, our company has determined that this product meets the ENERGY STAR® guidelines for energy efficiency. ENERGY STAR® is a U.S. registered mark.

If you need additional assistance for set-up or operating after reading owner's manual, please call **TOLL FREE : 1-800-968-3429**. Or visit our **WEB SITE** at <http://www.funai-corp.com>

Please read before using this equipment

WARNING: TO REDUCE THE RISK OF FIRE OR ELECTRIC SHOCK, DO NOT EXPOSE THIS APPLIANCE TO RAIN OR MOISTURE.



CAUTION
RISK OF ELECTRIC SHOCK
DO NOT OPEN



CAUTION: TO REDUCE THE RISK OF ELECTRIC SHOCK, DO NOT REMOVE COVER (OR BACK). NO USER SERVICEABLE PARTS INSIDE. REFER SERVICING TO QUALIFIED SERVICE PERSONNEL.



THIS SYMBOL INDICATES THAT DANGEROUS VOLTAGE CONSTITUTING A RISK OF ELECTRIC SHOCK IS PRESENT WITHIN THIS UNIT.



THIS SYMBOL INDICATES THAT THERE ARE IMPORTANT OPERATING AND MAINTENANCE INSTRUCTIONS IN THE LITERATURE ACCOMPANYING THE APPLIANCE.

The caution marking is located on the rear of the cabinet.

IMPORTANT SAFEGUARDS

- 1. Read instructions-**All the safety and operating instructions should be read before the appliance is operated.
- 2. Retain Instructions-**The safety and operating instructions should be retained for future reference.
- 3. Heed Warnings-**All warnings on the appliance and in the operating instructions should be adhered to.
- 4. Follow Instructions-**All operating and use instructions should be followed.
- 5. Cleaning-**Unplug TV/DVD from the wall outlet before cleaning. Do not use liquid cleaners or aerosol cleaners. Use a damp cloth for cleaning.
EXCEPTION: A product that is meant for uninterrupted service and, that for some specific reason, such as the possibility of the loss of an authorization code for a CATV converter, is not intended to be unplugged by the user for cleaning or any other purpose, may exclude the reference to unplugging the appliance in the cleaning description otherwise required in item 5.
- 6. Attachments-**Do not use attachments not recommended by the TV/DVD manufacturer as they may cause hazards.
- 7. Water and Moisture-**Do not use this TV/DVD near water—for example, near a bath tub, wash bowl, kitchen sink, or laundry tub, in a wet basement, or near a swimming pool, and the like.
- 8. Accessories-**Do not place this TV/DVD on an unstable cart, stand, tripod, bracket, or table. The TV/DVD may fall, causing serious injury to someone, and serious damage to the appliance. Use only with a cart, stand, tripod, bracket, or table recommended by the manufacturer, or sold with the TV/DVD. Any mounting of the appliance should follow the manufacturer's instructions and should use a mounting accessory recommended by the manufacturer. An appliance and cart combination should be moved with care.
Quick stops, excessive force, and uneven surfaces may cause the appliance and cart combination to overturn.

PORTABLE CART WARNING
AVERTISSEMENT POUR UNE
TABLE ROULANTE PORTATIVE



S3126A

Accessoires- Ne placez pas cette TV/DVD sur une table roulante, un support, un trépied, une console ou une table instable. Cette TV/DVD risquerait de tomber, pouvant gravement blesser quelqu'un et l'appareil même pourrait être sérieusement endommagé. N'utilisez qu'une table roulante, un support, un trépied, une console ou une table recommandé par le fabricant, ou vendu avec la TV/DVD. Pour n'importe quelle installation de l'appareil, on devra suivre les instructions du fabricant et l'on devra utiliser les accessoires d'installation recommandés par le fabricant. L'ensemble combiné de l'appareil avec une table roulante devra être déplacé avec précaution. Des arrêts brusques, une force excessive et des surfaces inégales peuvent provoquer le renversement de l'ensemble combiné de l'appareil/table roulante.

- 9. Ventilation-**Slots and openings in the cabinet and the back or bottom are provided for ventilation and to ensure reliable operation of the TV/DVD and to protect it from overheating, and these openings must not be blocked or covered. The openings should never be blocked by placing the TV/DVD on a bed, sofa, rug, or other similar surface. This TV/DVD should never be placed near or over a radiator or heat register. This TV/DVD should not be placed in a built-in installation such as a bookcase or rack unless proper ventilation is provided or the manufacturer's instructions have been adhered to.
- 10. Power Sources-**This TV/DVD should be operated only from the type of power source indicated on the marking label. If you are not sure of the type of power supply to your home, consult your appliance dealer or local power company. For TV/DVDs intended to operate from battery power, or other sources, refer to the operating instructions.
- 11. Grounding or Polarization-**This TV/DVD is equipped with a polarized alternating-current line plug (a plug having one blade wider than the other). This plug will fit into the power outlet only one way. This is a safety feature. If you are unable to insert the plug fully into the outlet, try reversing the plug. If the plug should still fail to fit, contact your electrician to replace your obsolete outlet. Do not defeat the safety purpose of the polarized plug.

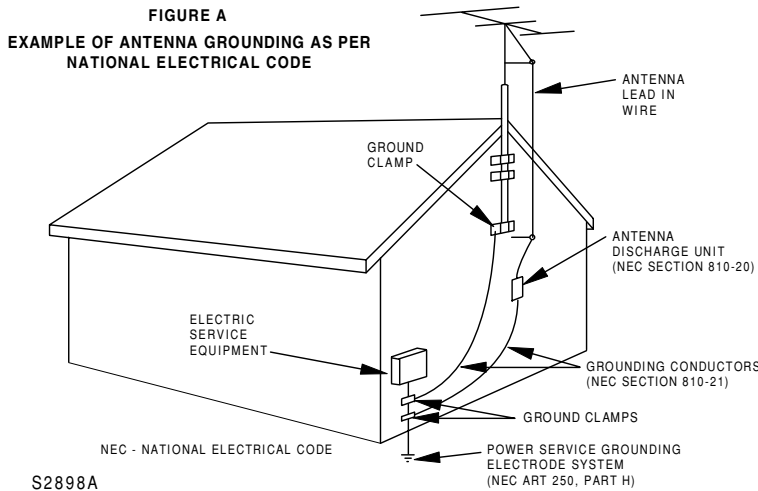

12. Power-Cord Protection-Power-supply cords should be routed so that they are not likely to be walked on or pinched by items placed upon or against them, paying particular attention to cords at plugs, convenience receptacles, and the point where they exit from the appliance.

13. Outdoor Antenna grounding-If an outside antenna or cable system is connected to the TV/DVD, be sure the antenna or cable system is grounded so as to provide some protection against voltage surges and built-up static charges. Article 810 of the National Electrical Code, ANSI/NFPA No. 70, provides information with respect to proper grounding of the mast and supporting structure, grounding of the lead-in wire to an antenna discharge unit, size of grounding conductors, location of antenna-discharge unit, connection to grounding electrodes, and requirements for the grounding electrode. (Fig. A)

14. Lightning-For added protection for this TV/DVD receiver during a lightning storm, or when it is left unattended and unused for long periods of time, unplug it from the wall outlet and disconnect the antenna or cable system. This will prevent damage to the TV/DVD due to lightning and power-line surges.

15. Power Lines-An outside antenna system should not be located in the vicinity of overhead power lines or other electric light or power circuits, or where it can fall into such power lines or circuits. When installing an outside antenna system, extreme care should be taken to keep from touching such power lines or circuits as contact with them might be fatal.

16. Overloading-Do not overload wall outlets and extension cords as this can result in a risk of fire or electric shock.

17. Object and Liquid Entry-Never push objects of any kind into this TV/DVD through openings as they may touch dangerous voltage points or short out parts that could result in a fire or electric shock. Never spill liquid of any kind on the TV/DVD.

18. Servicing-Do not attempt to service this TV/DVD yourself as opening or removing covers may expose you to dangerous voltage or other hazards. Refer all servicing to qualified service personnel.

19. Damage Requiring Service-Unplug this TV/DVD from the wall outlet and refer servicing to qualified service personnel under the following conditions:

- a. When the power-supply cord or plug is damaged or frayed.
- b. If liquid has been spilled, or objects have fallen into the TV/DVD.
- c. If the TV/DVD has been exposed to rain or water.
- d. If the TV/DVD does not operate normally by following the operating instructions. Adjust only those controls that are covered by the operating instructions, as improper adjustment of other controls may result in damage and will often require extensive work by a qualified technician to restore the TV/DVD to its normal operation.
- e. If the TV/DVD has been dropped or damaged in any way.
- f. When the TV/DVD exhibits a distinct change in performance-this indicates a need for service.

20. Replacement Parts-When replacement parts are required, be sure the service technician has used replacement parts specified by the manufacturer that have the same characteristics as the original part. Unauthorized substitutions may result in fire, electric shock, injury to persons or other hazards.

21. Safety Check-Upon completion of any service or repairs to this TV/DVD, ask the service technician to perform routine safety checks to determine that the TV/DVD is in proper operating condition.

22. Heat-This TV/DVD product should be situated away from heat sources such as radiators, heat registers, stoves, or other products (including amplifiers) that produce heat.

PRECAUTIONS

IMPORTANT COPYRIGHT INFORMATION

Unauthorized copying, broadcasting, public performance and lending of discs are prohibited.

This product incorporates copyright protection technology that is protected by method claims of certain U.S. patents and other intellectual property rights owned by Macrovision Corporation and other rights owners. Use of this copyright protection technology must be authorized by Macrovision Corporation, and is intended for home and other limited viewing uses only unless otherwise authorized by Macrovision Corporation. Reverse engineering or disassembly is prohibited.

FCC WARNING- This equipment may generate or use radio frequency energy. Changes or modifications to this equipment may cause harmful interference unless the modifications are expressly approved in the instruction manual. The user could lose the authority to operate this equipment if an unauthorized change or modification is made.

RADIO-TV INTERFERENCE

This equipment has been tested and found to comply with the limits for a Class B digital device, pursuant to Part 15 of the FCC Rules. These limits are designed to provide reasonable protection against harmful interference in a residential installation.

This equipment generates, uses, and can radiate radio frequency energy and, if not installed and used in accordance with the instructions, may cause harmful interference to radio communications.

However, there is no guarantee that interference will not occur in a particular installation. If this equipment does cause harmful interference to radio or television reception, which can be determined by turning the equipment off and on, the user is encouraged to try to correct the interference by one or more of the following measures:

- 1) Reorient or relocate the receiving antenna.
- 2) Increase the separation between the equipment and receiver.
- 3) Connect the equipment into an outlet on a circuit different from that to which the receiver is connected.
- 4) Consult the dealer or an experienced radio/TV technician for help.

LASER SAFETY

This unit employs a laser. Only a qualified service person should remove the cover or attempt to service this device, due to possible eye injury.

CAUTION: USE OF CONTROLS OR ADJUSTMENTS OR PERFORMANCE OF PROCEDURES OTHER THAN THOSE SPECIFIED HEREIN MAY RESULT IN HAZARDOUS RADIATION EXPOSURE.

CAUTION: VISIBLE AND INVISIBLE LASER RADIATION WHEN OPEN AND INTERLOCK DEFEATED. DO NOT STARE INTO BEAM.

LOCATION: INSIDE, NEAR THE DECK MECHANISM.

This Class B digital apparatus complies with Canadian ICES-003.

Cet appareil numérique de la classe B est conforme à la norme NMB-003 du Canada.

CAUTION: TO PREVENT ELECTRIC SHOCK, MATCH WIDE BLADE OF PLUG TO WIDE SLOT, FULLY INSERT.

ATTENTION: POUR ÉVITER LES CHOCS ÉLECTRIQUES, INTRODUIRE LA LAME LA PLUS LARGE DE LA FICHE DANS LA BORNE CORRESPONDANTE DE LA PRISE ET POUSSER JUSQU'AU FOND.

A NOTE ABOUT RECYCLING

This product's packaging materials are recyclable and can be reused. Please dispose of any materials in accordance with your local recycling regulations.

Batteries should never be thrown away or incinerated but disposed of in accordance with your local regulations concerning chemical wastes.

The serial number of this product may be found on the back of the unit. No other TV/DVD has the same serial number as yours. You should record the number and other vital information here and retain this book as a permanent record of your purchase to aid identification in case of theft. Serial numbers are not kept on file.

Date of Purchase	
Dealer Purchase from	
Dealer Address	
Dealer Phone No.	
Model No.	
Serial No.	

LOCATION

For safe operation and satisfactory performance of your TV/DVD, keep the following in mind when selecting a place for its installation:

- Shield it from direct sunlight and keep it away from sources of intense heat.
- Avoid dusty or humid places.
- Avoid places with insufficient ventilation for proper heat dissipation. Do not block the ventilation holes at the top or bottom of the unit. Do not place the unit on a carpet because this will block the ventilation holes.
- Install unit in a horizontal position.
- Avoid locations subject to strong vibration.
- Do not place the TV/DVD near strong magnetic fields.
- Avoid moving TV/DVD to locations where temperature differences are extreme.

AVOID THE HAZARDS OF ELECTRICAL SHOCK AND FIRE

- Do not handle the power cord with wet hands.
- Do not pull on the power cord when disconnecting it from an AC wall outlet. Grasp it by the plug.
- If by accident, water is spilled on your unit, unplug the power cord immediately and take the unit to our Authorized Service Center for servicing.
- Do not put your fingers or objects into the TV/DVD disc loading tray.
- Do not place anything directly on top of the unit.

SYMBOLS USED IN THIS MANUAL

The following symbols below appear in some headings and notes in this manual, with the following meanings

TV

: Description refers to TV operation (in the TV mode).

DVD-V

: Description refers to playback of DVD video discs (in the DVD mode).

CD

: Description refers to playback of audio CDs (in the DVD mode).

MP3

: Description refers to playback of MP3 discs (in the DVD mode).

QUICK

: Description refers to the items to be set by the QUICK mode (in the DVD mode).

WARNING

Moisture condensation may occur inside the unit when it is moved from a cold place to a warm place or after heating a cold room or under conditions of high humidity. If a DVD is played in a TV/DVD which has moisture, it may damage the DVD and TV/DVD. Therefore when the condensation occurs inside the unit, turn POWER on and allow at least 2 hours for the unit to dry out.

SUPPLIED ACCESSORIES

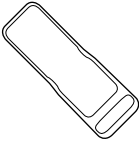
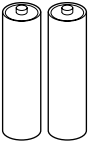
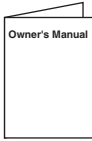
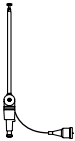
Remote Control Unit	Batteries	Owner's Manual	Rod Antenna
 <p>NE220UD</p>	 <p>2 AA Batteries</p>	 <p>1EMN20016</p>	 <p>0EMN01755 or 0EMN00673 or 0EMN01599</p>

- If you need to replace these accessories, please refer to the PART NO. under the illustrations and call 1-800-968-3429.
- Depending on your antenna system, you may need different types of Combiners (Mixer) or Separators (Splitter). Contact your local electronics store for these items.
- We do not recommend the use of universal remote controls. Not all of the functions may be controlled with a universal remote control. If you decide to use a universal remote control with this unit, please be aware that the code number given may not operate this unit. In this case, please call the manufacturer of the universal remote control.

TABLE OF CONTENTS

■ IMPORTANT SAFEGUARDS	2	■ SEARCH FUNCTION	22
■ PRECAUTIONS	4	TRACK SEARCH	22
LOCATION	5	TITLE / CHAPTER SEARCH	22
AVOID THE HAZARDS OF ELECTRICAL SHOCK AND FIRE	5	TIME SEARCH	22
SYMBOLS USED IN THIS MANUAL	5	MARKER SETUP SCREEN	22
WARNING	5	■ SPECIAL PLAYBACK FUNCTION	23
■ SUPPLIED ACCESSORIES	5	REPEAT	23
■ TABLE OF CONTENTS	6	PROGRAM	23
■ FEATURES	7	RANDOM PLAYBACK	23
■ OPERATING CONTROLS AND FUNCTIONS ..	8	■ PLAYING A MP3 DISC	24
INSTALLING THE BATTERIES	9	MP3 PLAYBACK	24
■ PREPARATION FOR USE	10	REPEAT	24
ANTENNA/CABLE CONNECTIONS	10	PROGRAM	24
CONNECTING TO EXTERNAL INPUT JACKS ..	11	RANDOM PLAYBACK	24
CONNECTING TO AN AMPLIFIER EQUIPPED WITH DIGITAL INPUT JACKS, MD DECK OR DAT DECK (for DVD only) ..	11	■ CHANGING THE SETTINGS	25
CONNECTING TO A DOLBY DIGITAL DECODER (for DVD)	12	SUBTITLE LANGUAGE	25
TV SECTION		AUDIO LANGUAGE	25
■ SET UP FOR USE	13	STEREO SOUND MODE	25
SELECTING THE LANGUAGE	13	CAMERA ANGLE	25
CHANNEL SET UP	13	BLACK LEVEL SETTING	25
DELETING (OR ADDING) CHANNEL(S) ..	14	VIRTUAL SURROUND	25
■ TV OPERATION	15	■ THE ON-SCREEN INFORMATION	26
WATCHING A TV PROGRAM	15	■ CHANGING THE DVD SETUP ITEMS ..	27
DEGAUSSING	15	LANGUAGE SETTING	27
PICTURE CONTROL	15	DISPLAY SETTING	28
SLEEP TIMER	16	AUDIO SETTINGS	28
CLOSED CAPTION SYSTEM	16	PARENTAL CONTROL	29
V-CHIP SET UP	17	INITIALIZE	29
■ DVD SECTION		■ TROUBLESHOOTING GUIDE	30
■ ABOUT THE DISCS	19	■ MAINTENANCE	32
PLAYABLE DISCS	19	DISC HANDLING	32
DISC TYPES	19	■ SPECIFICATIONS	33
■ PLAYING A DISC	20	■ ESPAÑOL	34
BASIC PLAYBACK	20	■ WARRANTY	Back Cover
GENERAL FEATURES	20		
DISC MENU	20		
TITLE MENU	20		
RESUME	21		
PAUSE	21		
STEP BY STEP PLAYBACK	21		
FAST FORWARD/REVERSE SEARCH	21		
SLOW FORWARD / SLOW REVERSE	21		

FEATURES

TV Mode

- **181 channel capability PLL frequency synthesizer tuner with direct station call**
(A converter may be necessary to view scrambled cable channels.)
- **Infrared remote control**
- **Trilingual on screen menu display selectable in English, Spanish, or French**
- **Sleep Timer**
The Sleep Timer function enables you to shut off the power without pressing POWER after a desired time period.
- **Closed Caption Decoder**
You may view specially labeled (cc) TV programs, movies, news, etc. with either a dialogue caption or text display added to the program.
- **Auto Shut Off Function**
If there is no air signal input from the antenna terminal and no operation for 15 minutes, the TV/DVD will turn itself off automatically.
- **V-CHIP**
Enables parents to prevent their children from watching inappropriate material on TV.

DVD Mode

- **Dolby Digital sound**
This TV/DVD can handle Dolby Digital surround sound having 5.1 channels when connected to a Dolby Digital decoder.
- **Still/fast/slow/step playback**
Various playback modes are available including still pictures, fast forward/reverse, slow motion and step frames.
- **Random playback for audio CD and MP3**
This TV/DVD can shuffle the order of tracks to play them in random order.
- **Program playback for audio CD and MP3**
You can program the order of tracks to play them in any desired order.
- **DVD menus in a desired language**
You can display DVD menus in a desired language, if available on a DVD.
- **Screen saver/Auto power-off functions**
The screen saver program starts when there is no input from the TV/DVD for five minutes in the stop mode. When the screen saver program is activated for 15 minutes, the power is automatically turned off.
- **Subtitles in a desired language**
You can select a desired language for the display subtitles, if that language is available on a disc.
- **Selecting a camera angle**
You can select the desired camera angle, if a disc contains sequences recorded from different angles.
- **Choices for audio language and sound mode**
You can select the desired audio language and sound mode, if different languages and modes are available on a disc.
- **Parental lock**
You can set the control level to limit playback of discs which may not be suitable for children.
- **Automatic detection of discs**
This TV/DVD automatically detects if the loaded disc is DVD, audio CD or MP3 on disc.
- **On-screen display**
Information about the current operation can be displayed on a TV screen, allowing you to confirm the currently active functions (such as program playback), on the TV screen using the remote control.
- **Search**
Chapter search / Title search / Track search / Time search
- **Repeat**
Chapter / Title / Track / Group / All / A-B
- **Marker**
The part designated by user can be called back.
- **Resume Play**
User can resume to playback from the part at which the play was stopped.
- **Virtual Surround**
- **Bit rate indication**
- **DRC (Dynamic range control)**
You can control the range of sound volume.

OPERATING CONTROLS AND FUNCTIONS

TV/DVD FRONT PANEL [Fig. 1]

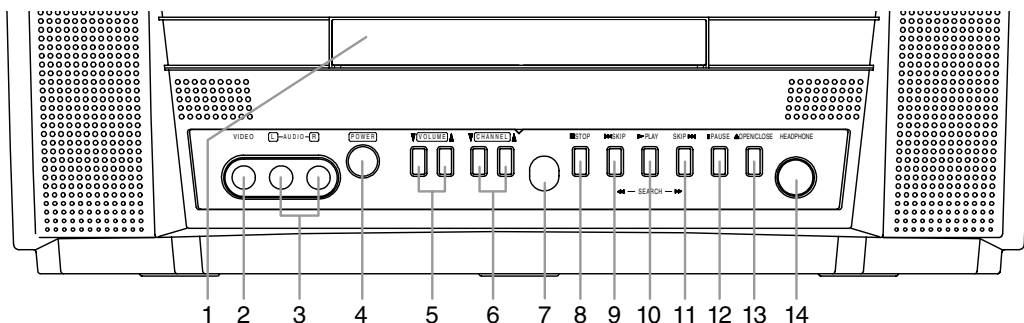

REMOTE CONTROL [Fig. 2]

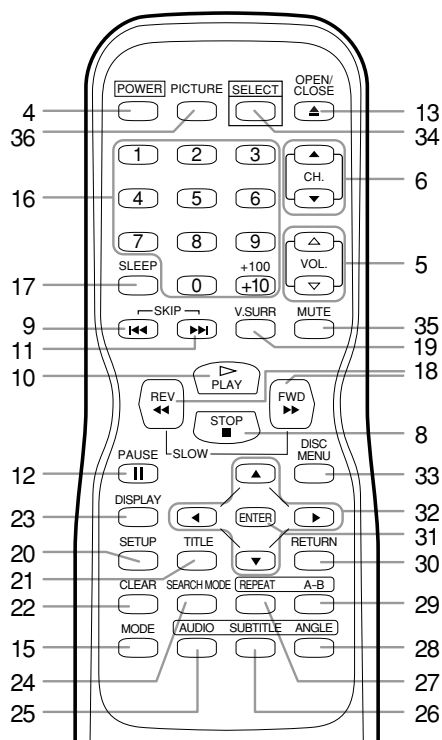

1. Disc loading tray

2. VIDEO input Jack [page 11]

Connect to the video output jack of a video camera or VCR.

3. AUDIO L/R input Jacks [page 11]

Connect to the audio output jacks of a video camera or VCR.

4. POWER Button [page 13]

Press to turn the power on and off.

5. VOLUME ▲/▼ (VOL. ▲/▼) Buttons

Press to control the volume level for the DVD and TV.

6. CHANNEL ▲/▼ (CH. ▲/▼) Buttons [page 14]

Press to select memorized channel.

Press to change to TV mode when DVD mode.

7. Remote Sensor Window

8. STOP Button [page 20]

Stops operation of the disc.

9. SKIP ◀◀ Button [page 21]

Plays back from the beginning of the current chapter or track.

SEARCH (REV) ◀◀ Button (Front Panel) [page 21]

During playback or in the pause mode, press and hold button down for a few seconds to change reverse playback speed.

10. PLAY Button [page 20]

Starts playback of the disc contents.

Press to change to DVD mode when TV mode.

11. SKIP ▶▶ Button [page 21]

Plays back from the beginning of the next chapter or track.

SEARCH (FWD) ▶▶ Button (Front Panel) [page 21]

During playback or in the pause mode, press and hold button down for a few seconds to change forward playback speed.

12. PAUSE Button [page 21]

Pauses the current disc operation.

13. OPEN/CLOSE Button [page 20]

Press to insert discs into or remove them from the tray.

14. HEADPHONE Jack

To connect headphone (not supplied) for personal listening.

15. MODE Button [pages 23-25]

Activates program playback or random playback mode when playing CDs or MP3.

16. Number Buttons

TV Mode: [page 15]

Press two digits to directly access the desired channel. Remember to press 0 before a single digit channel.

+100 Button

Press to select cable channels which are higher than 99.

DVD Mode: [page 22]

Press to enter the desired number.

+10 Button

Press to enter the desired numbers which are greater than 9.

TV/DVD REAR VIEW

[Fig. 3]

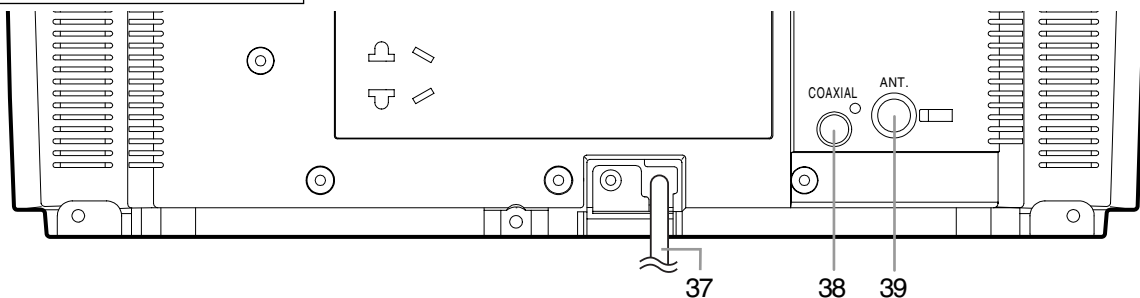

17. SLEEP Button [page 16]

Press SLEEP to display the sleep timer and start the function. The shut off time can be determined by the number of times you press this button. (0, 30, 60, 90, or 120 minutes)

18. REV ◀◀ Button [page 21]

Press to view the DVD picture in fast reverse motion. Press PAUSE, then press this button to begin slow motion playback. Press this button repeatedly to change the reverse speed of slow motion.

FWD ▶▶ Button [page 21]

Press to fast forward the Disc. Press PAUSE, then press this button to begin slow motion playback. Press this button repeatedly to change the forward speed of slow motion.

19. V.SURR (VIRTUAL SURROUND) Button [page 25]

Press to set virtual surround on/off.

20. SETUP Button [pages 13,27-29]

Press to enter or exit the TV menu or DVD setup mode.

21. TITLE Button [page 20]

Displays the title menu.

22. CLEAR Button [pages 22-24]

Resets a setting.

23. DISPLAY Button

TV Mode:

Press to display the channel number on the screen. If you press it again, the channel number will disappear.

DVD Mode: [page 26]

Displays the current status on the TV screen for checking purposes.

24. SEARCH MODE Button [page 22]

Press to locate a desired point.

25. AUDIO Button [page 25]

Press to select a desired audio language or sound mode.

26. SUBTITLE Button [page 25]

Press to select a desired subtitle language.

27. REPEAT Button [page 23]

Repeats playback of the current disc, title, chapter group or track.

28. ANGLE Button [page 25]

Press to change the camera angle to see the sequence being played back from a different angle.

29. REPEAT A-B Button [page 23]

Repeats playback of a selected section.

30. RETURN Button [page 25]

Returns to the previous operation in the DVD setup mode.

31. ENTER Button [pages 13, 20]

Press to accept a setting.

32. Arrow Buttons

TV Mode: [page 13]

Press to select a setting mode from the menu on the TV screen.

Press to select or adjust from a particular menu.

DVD Mode: [page 20]

Use when making settings while watching the display on a TV screen.

33. DISC MENU Button [page 20]

Displays the menus in the DVD.

34. SELECT Button [page 20]

Press to change to TV mode, external input mode or DVD mode.

NOTE: When you select the DVD mode by this button, press PLAY or OPEN/CLOSE first. Otherwise, the DVD features are not operated.

35. MUTE Button

Press MUTE to turn off the sound portion of the TV program. (Volume level display turns LIGHT RED from LIGHT BLUE.) Press MUTE again or press VOL. Δ or ∇ to restore sound.

36. PICTURE Button [page 15]

Press to enter picture adjustment mode.

37. Power cord

Connect to a standard AC outlet (120V/60Hz).

NOTE: Remove the power cord from the hook to avoid breaking a wire before you connect to a standard AC outlet.

38. COAXIAL digital audio out Jack (DVD Audio Only) [pages 11, 12]

Connect to the digital input of an external amplifier or decoder.

39. ANT. in Jack

Connect to an antenna, cable system, or satellite system.

INSTALLING THE BATTERIES

- 1) Open the battery compartment cover by pressing the cover on the remote unit in the direction of the arrow.
- 2) Insert 2 "AA" penlight batteries into the battery compartment in the direction indicated by the polarity (+/-) markings.
- 3) Replace the cover.



NOTES

- Do not mix alkaline and manganese batteries.
- Do not mix old and new batteries.

PREPARATION FOR USE

ANTENNA/CABLE CONNECTIONS

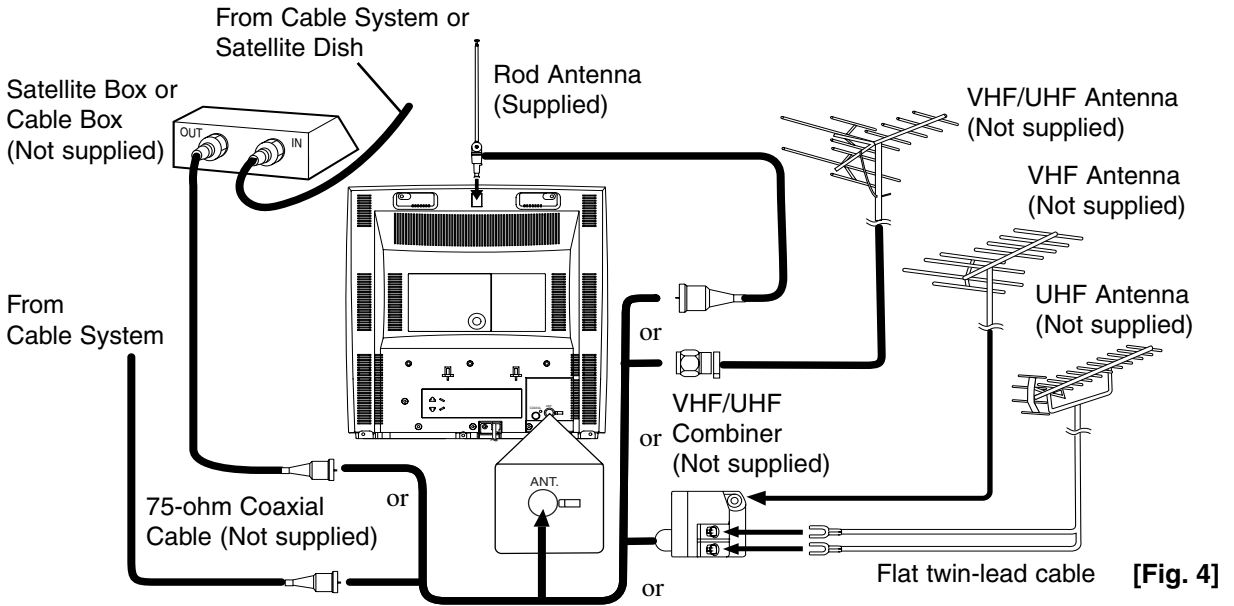

[Fig. 4]

Note to CATV system installer:

This reminder is provided to call the CATV system installer's attention to Article 820-40 of the NEC that provides guidelines for proper grounding and in particular, specifies that the cable ground shall be connected to the grounding system of the building as close to the point of cable entry as practical.

NOTE:

Before plugging the antenna into the ANT. IN jack of the TV/DVD, check that the pin is not bent. If it is bent, straighten the pin as illustrated, then plug the pin into the ANT. IN jack of the TV/DVD.

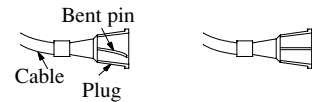

(Needs to be straightened)(Straight pin)

VHF/UHF COMBINED ANTENNA

The VHF/UHF Rod Antenna (supplied) is detachable. Insert the stem of the antenna into the hole on the upper-back portion of the TV/DVD. Connect the VHF/UHF Rod Antenna or VHF/UHF Combination Antenna to the ANT. terminal of the TV/DVD as shown in the diagram above. For the best reception, fully extend the VHF/UHF Rod Antenna and make the necessary adjustments. (Avoid touching the top section when adjusting.)

VHF/UHF SEPARATE ANTENNAS

In some areas it will be necessary to use an outdoor antenna.

CABLE WITHOUT CONVERTER/DESCRAMBLER BOX

Use this connection if your cable system connects directly to your TV/DVD without a converter box. Use the TV/ DVD Remote Control to select channels.

CABLE WITH CONVERTER/DESCRAMBLER BOX OR SATELLITE BOX

If your cable service supplies you with a converter box or if you use a satellite system, you can use the basic connection shown here.

Channel selection must be made with the converter box or satellite box. This means that channels cannot be changed using the TV/ DVD Remote Control.

TO VIEW A SCRAMBLED/UNSCRAMBLED CHANNEL

1. Set the TV/DVD channel selector to the output channel of the Cable Converter Box or Satellite Box. (Ex. CH3)
2. Select the channel to view on your Cable Converter Box or Satellite Box.

CONNECTING TO EXTERNAL INPUT JACKS

When you watch a program recorded on an another source (VCR or video camera), use the audio/video input jacks on the front of the TV/DVD.

Connect the audio/video output jacks of another source to the AUDIO L/R and VIDEO jacks of this TV/DVD. Then press SELECT until "AUX" appears on the screen.

NOTE:

- When you connect a monaural VCR (another source) to this TV/DVD, connect the Audio output jack of the monaural VCR (another source) to the AUDIO L jack of this TV/DVD. The audio will output in both L and R channel equally.

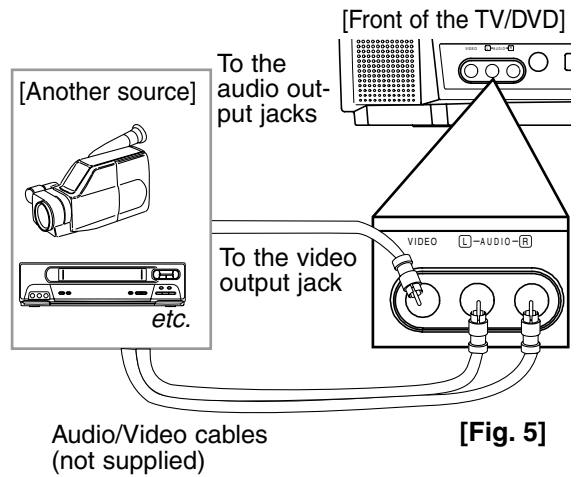

[Fig. 5]

CONNECTING TO AN AMPLIFIER EQUIPPED WITH DIGITAL INPUT JACKS, MD DECK OR DAT DECK (for DVD only)

Use an audio coaxial digital cable available at retail for the audio connections.

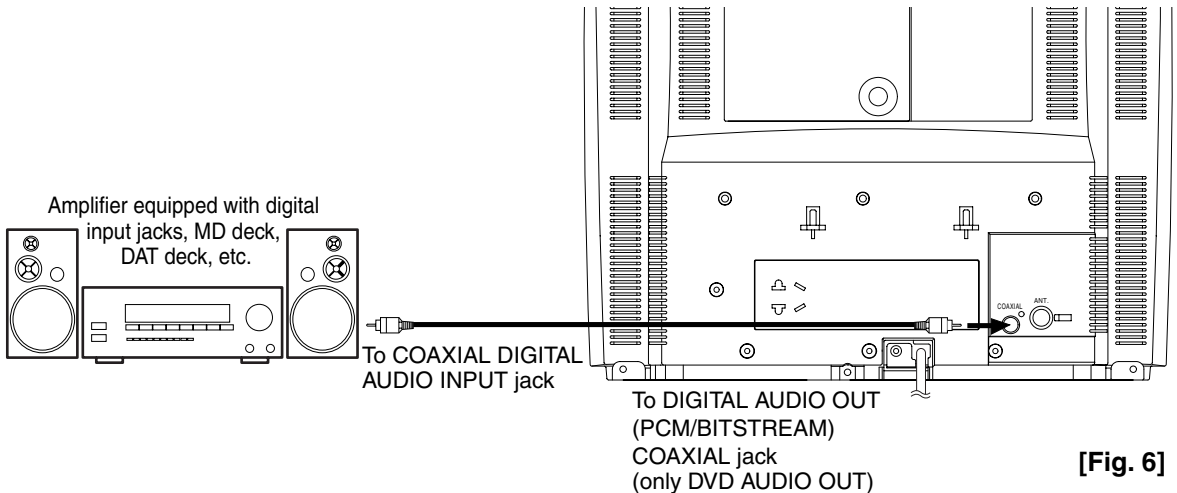

[Fig. 6]

NOTES:

- The audio source on a disc in a 5.1 channel Dolby Digital surround format cannot be recorded as digital sound by an MD or DAT deck.
- Be sure to turn off the power to all components in the system before connecting another component.
- Refer to the Owner's Manuals for the components to be connected to the TV/DVD.
- Set DOLBY DIGITAL to OFF for audio output in the setup mode. Playing a TV/DVD using incorrect settings may generate noise distortion and may also damage the speakers. (See page 28 to set DOLBY DIGITAL to OFF.)

CONNECTING TO A DOLBY DIGITAL DECODER (for DVD)

If using this TV/DVD to play a DVD disc in a 5.1 channel Dolby Digital surround format, the TV/DVD outputs a DOLBY DIGITAL Data stream from its COAXIAL digital audio out jack. By hooking the TV/DVD up to a Dolby Digital decoder, you can enjoy a more convincing, realistic ambience with powerful and high-quality surround sound as enjoyed in movie theaters.

Use audio coaxial digital cables available at retail for the audio connections.

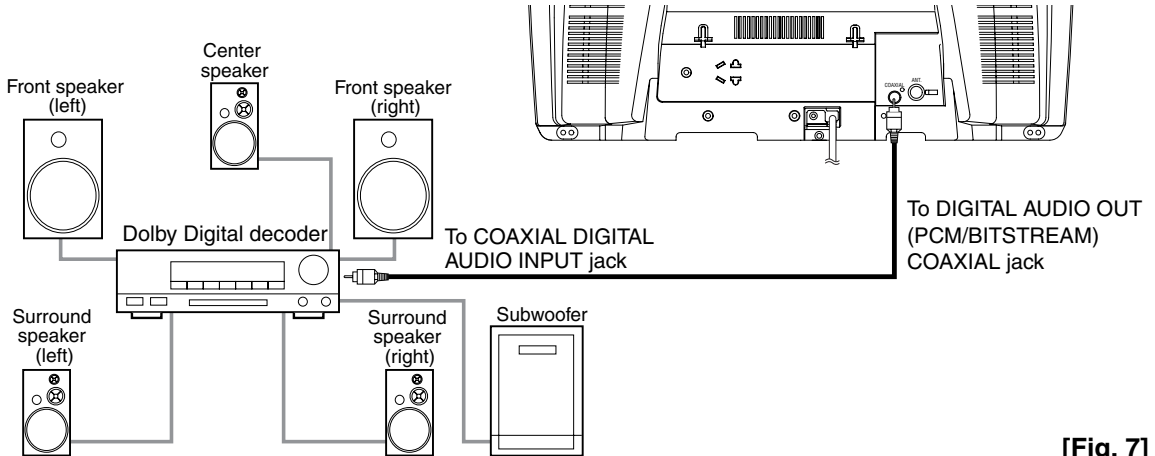

[Fig. 7]

NOTES:

- Be sure to turn off the power to all components in the system before connecting another component.
- Refer to the Owner's Manuals for the components to be connected to the TV/DVD.
- If connected to a Dolby Digital decoder, set DOLBY DIGITAL to ON for audio output in the setup mode. (See page 28 to set DOLBY DIGITAL to ON.)
- Unless connected to a Dolby Digital decoder, set DOLBY DIGITAL to OFF for audio output in the setup mode. Playing a TV/DVD using incorrect settings may generate noise distortion and may also damage the speakers.

Manufactured under license from Dolby Laboratories. "Dolby" and the double-D symbol are trademarks of Dolby Laboratories.

SET UP FOR USE

SELECTING THE LANGUAGE

TV

1 Plug in the TV/DVD power cord

Plug the TV/DVD power cord into a standard AC outlet.

NOTE:

- If any digits appear in the corner of the screen, press POWER without unplugging the power cord.

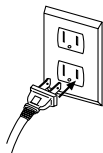
**Make sure ...**

- Press POWER to turn on the TV/DVD.

NOTE: This function effects only the language on the screen menu and not the audio source.

2 Select "LANGUAGE"

Press SETUP on the remote control.

Press Arrow (▲/▼) to point to "LANGUAGE".

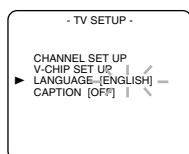
**3 Select "ENGLISH", "ESPAÑOL" or "FRANÇAIS"**

Select "ENGLISH", "ESPAÑOL"= Spanish or "FRANÇAIS"= French using ENTER.

4 Exit the Language mode

Press SETUP to return to TV mode.

NOTE: If for some reason the menu is in Spanish or French, press SETUP, press Arrow (▲/▼) to point to "IDIOMA [ESPAÑOL]" or "LANGAGE [FRANÇAIS]", then press ENTER, then press SETUP on the remote control.

CHANNEL SET UP

TV

You can program the tuner to scan all the channels you receive in your area.

NOTE: Channel memory programming is NOT needed when connected to a cable box or satellite box. Just select the TV/DVD channel selector to the output channel of the cable box or satellite box (Ex CH3), then select the channel to be viewed on the Cable Box or Satellite Box.

Make sure ...

- Press POWER to turn on the TV/DVD.

1 Select "CHANNEL SET UP"

Press SETUP on the remote control.

Press Arrow (▲/▼) to point to "CHANNEL SET UP".

Then press ENTER.

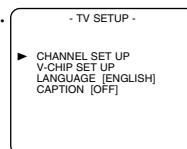
**2 Begin auto ch programming**

Press Arrow (▲/▼) to point to "AUTO CH PROGRAMMING".

Then press ENTER.

The tuner scans and memorizes all the active channels in your area.

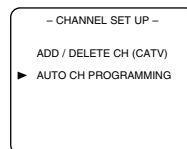
**3 After scanning**

The tuner stops on the lowest memorized channel.

- When AUTO CH PROGRAMMING is activated where there is no TV signal input, "NO TV SIGNALS" will appear on the display after the completion of the channel scanning.
- The TV/DVD may recognize TV channels to be CATV channels by the receiving conditions. In this case, try auto ch programming again in the fine receiving conditions.

DELETING (OR ADDING) CHANNEL(S)

TV

The channels you no longer receive or seldom watch can be deleted from the memory. (Of course, you can add the deleted channel into the memory again.)

1 Select "CHANNEL SET UP"

Press **SETUP** on the remote control.

Press Arrow (▲/▼) to point to "CHANNEL SET UP".

Then press **ENTER**.

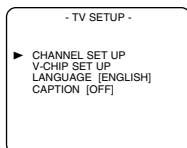

2 Select "ADD/DELETE CH"

Press Arrow (▲/▼) to point to "ADD/DELETE CH".

Press **ENTER**.

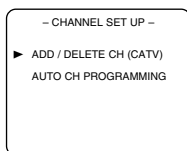

3 Enter the desired channel number

Press Arrow (▲/▼) until your desired channel number appears. (You can also use the number buttons or **CHANNEL(CH.)** ▲/▼ to enter it) (Example: CH8)

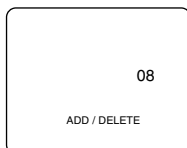

- You must precede single-digit channel numbers with a zero (Example: 02 ... 09).
- When selecting cable channels which are higher than 99, press +100 first, then press the last two digits. (Example: to select channel 125, first press +100, then press 2 and 5).

4 Delete (or add) it from (into) memory

Press **ENTER**. The channel number changes to light red. The channel is deleted from memory.

- To delete another channel, repeat steps [3] and [4].
- If you press **ENTER** again, the channel is memorized again.

Added channel: Light blue.
Deleted channel: Light red.

5 Exit the channel setup mode

Press **SETUP** to return to TV mode.

NOTE: To confirm that channel(s) has been deleted or added, press **CHANNEL(CH.)** ▲/▼.

TV OPERATION

WATCHING A TV PROGRAM

TV

1 Turn on the TV/DVD

Press POWER to turn on the TV/DVD.

2 Select the channel number

Press CHANNEL(CH.) ▲/▼ to select your desired channel number, or press the number buttons.

Notes for using the number buttons on the remote control:

- You must precede single-digit channel numbers with a zero (Example: 02 ... 09).
- When selecting cable channels which are higher than 99, press +100 first, then press the last two digits. (Example: to select channel 125, first press +100, then press 2 and 5).

Remember:

- If the TV/DVD is connected to a cable box or satellite box, the TV/DVD must be on CH3 or CH4, then the channel to be viewed must be selected on the cable box or satellite box.

3 Adjust sound

Press VOLUME(VOL.) ▲/▼ to adjust the volume.

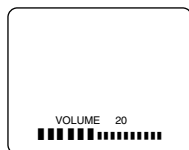

NOTE:

- If you press CHANNEL(CH.) ▲/▼ in the DVD mode, you can change the TV channels. Even if you turn off the TV/DVD in the DVD mode, when you turn it on again, it will go into the TV mode.

DEGAUSSING

Magnetism from nearby appliances and speakers might affect the color of the TV picture.

If this happens, move this unit away from the appliance. If the color is still not correct, disconnect power cord from AC outlet then reconnect it after 30 minutes.

PICTURE CONTROL

TV

The TV/DVD's picture controls – **BRIGHT, CONTRAST, COLOR, TINT** and **SHARPNESS** – are preset to factory specifications. Although they are usually the best, you may need to make some further adjustments for a more natural looking image.

Make sure ...

- TV/DVD power must be turned on.

1 Select "PICTURE CONTROL"

Press PICTURE on the remote control.

2 Select item you want to adjust

Press Arrow (▲/▼) until desired control is displayed.

BRIGHT
CONTRAST
COLOR
TINT
SHARPNESS

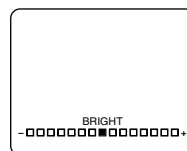

3 Adjust the picture control

Press Arrow (◀/▶) to adjust to your desired level within 5 seconds.

NOTE:

- At step [3], the picture adjustment display will disappear from the TV screen after about 5 seconds unless you press any buttons, even though you may not be finished. In this case, repeat from step [1].

	Arrow Button ◀	Arrow Button ▶
BRIGHT	to decrease brightness	to increase brightness
CONTRAST	to decrease contrast	to increase contrast
COLOR	to pale	to brilliant
TINT	to purple	to green
SHAPNESS	to soft	to clear

- If there is a power failure of any kind, the unit will retain its memory for this feature.

SLEEP TIMER

TV

The Sleep Timer function enables you to shut off the power without pressing POWER after a desired time period.

1 Set "SLEEP TIMER"

Press SLEEP on the remote control. You may change the sleep time with pressing SLEEP repeatedly. The timer is set up to 120 minutes, 30 minutes each time SLEEP is pressed.

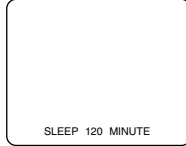

To cancel the sleep timer:

Press SLEEP repeatedly until "SLEEP 0 MINUTE" is displayed.

NOTES:

- When you disconnect the unit from the AC outlet, or if you have a power failure, the sleep time will be lost.
- To view the time left for sleep timer press SLEEP once when SLEEP display disappears. After 10 seconds, display will disappear again.

CLOSED CAPTION SYSTEM

TV

You can view specially labeled (cc) TV programs, movies, news, etc. with either a dialogue caption or text display.

CAPTION mode: By choosing the caption mode, you can watch dramas, movies and news while captioning the dialogues and the contents of news.

TEXT mode: By choosing the text mode, you can watch half screen text information if you want.

1-2: You may get these captions or text information by selecting either "1" or "2". Caption "2" is used, usually for a second language if available.

NOTE:

Not all programs are broadcast with closed captions. Your television is designed to provide error free closed captions from high quality antenna, cable and VCR signals. Conversely, poor quality signals are likely to result in caption errors or no captions at all. Common signal conditions which may cause caption errors are listed below:

- Automobile ignition noise
- Electric motor brush noise
- Weak snowy reception on TV screen
- Multiplex signal reception displaying picture ghosts or airplane flutter.

NOTE:

If the TV/DVD displays a black box on the TV screen, this means that the TV/DVD is set to the TEXT mode. To clear screen, select [CAPTION1], [CAPTION2] or [OFF].



Make sure ...

- TV/DVD power must be turned on.

1 Select "CAPTION"

Press SETUP on the remote control. Press ▲ or ▼ to point to "CAPTION".



2 Select your desired caption menu

Press ENTER until your desired caption menu appears. ([CAPTION1], [CAPTION2], [TEXT1] or [TEXT2])

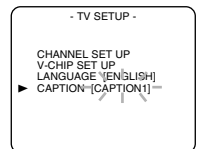

3 Exit the caption setting mode

Press SETUP to return to TV mode.

TO CANCEL THE CLOSED CAPTION SYSTEM

Repeat steps [1] and [2], select [OFF] using ENTER. Press SETUP on the remote control to return to TV mode.

WHEN THE CLOSED CAPTION MODE IS ON

The On-Screen Display will disappear after 5 seconds.

- This is also true when MUTE is pressed.
- If there is a power failure of any kind, the unit will retain its memory for this feature.

V-CHIP SET UP

TV

V-CHIP enables parents to prevent their children from watching inappropriate material on TV.

V-CHIP reads the ratings for programming (except for news and sports programs, unedited movies on premium cable channels, and Emergency Broadcast System signals), then denies access to programming if the program's rating meets the limitations you select. In this case, "PROTECTED PROGRAM by ..." message appears on the TV screen.

To block ratings, follow the steps below.

- Programming may be rated by the Motion Picture Association of America (MPAA) or according to the Television Parental Guidelines. In order to block any inappropriate programming, set your limits in both places (MPAA RATING and TV RATING).

TV RATING SET UP

Make sure ...

- TV/DVD power must be turned on.

1 Select "V-CHIP SET UP"

Press **SETUP** on the remote control.

Press Arrow (▲/▼) to point to "V-CHIP SET UP".

Then press **ENTER**.

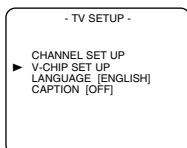

2 Input Access code

Press the number buttons to enter 4-digit access code. The default code is 0000.

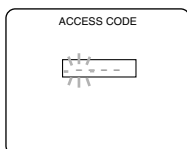

3 Select "TV RATING"

Press Arrow (▲/▼) to point to "TV RATING".

Then press **ENTER**.

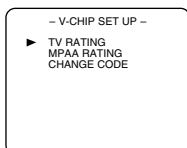

4 Select your desired item

Press Arrow (▲/▼) to point to your desired item.

Then press **ENTER** to select [BLOCK] or [VIEW].

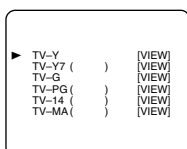

- When you select a rating category and turn it [BLOCK], the higher rating will turn [BLOCK] automatically. Also, the lower rating will turn [VIEW] automatically.
- When you turn "TV-Y" to [VIEW], all ratings will turn to [VIEW] automatically.

Selection	Rating Category Explanations
TV-Y	Appropriate for all children
TV-Y7	Appropriate for children seven and older
TV-G	General Audience
TV-PG	Parental Guidance suggested.
TV-14	Unsuitable for children under 14
TV-MA	Mature audience only

When you select TV-Y7, TV-PG, TV-14 or TV-MA and you press **ENTER**, the sub-ratings will appear on the TV screen.

If you select the rating category (example: TV-PG) and turn it [BLOCK] or [VIEW], the sub-ratings (example: V for Violence) will turn [BLOCK] or [VIEW] automatically.

You can set the sub-ratings to [BLOCK] or [VIEW] individually when the rating category is set to [BLOCK].

To set the sub-ratings individually, follow the steps below.

- **When you select [TV-Y7]:**

Press Arrow (▲/▼) to select "FV" (Fantasy Violence).

Then press **ENTER** to select [BLOCK] or [VIEW].

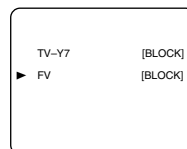

- **When you select [TV-PG], [TV-14] or [TV-MA]:**

Press Arrow (▲/▼) to select "D" (Suggestive Dialog),

"L" (Coarse Language),

"S" (Sexual Situation), or

"V" (Violence). Then press

ENTER to select [BLOCK] or [VIEW].

NOTE: When you select [TV-MA], "D" does not appear on the TV screen.

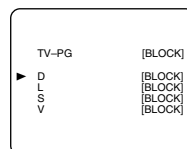

- The sub-ratings which set to [BLOCK] appears next to the rating category in the TV RATING menu.

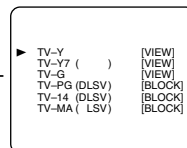

5 Exit the V-Chip setting mode

Press **SETUP** on the remote control to return to original mode.

MPAA RATING SET UP

Make sure ...

- TV/DVD power must be turned on.

1 Select "V-CHIP SET UP"

Press SETUP on the remote control.

Press Arrow (▲/▼) to point to "V-CHIP SET UP".

Then press ENTER.

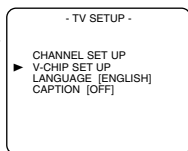

2 Enter 4-digit access code

Press the number buttons. The default code is 0000.

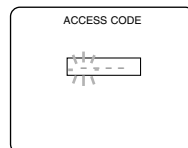

3 Select "MPAA RATING"

Press Arrow (▲/▼) to point to "MPAA RATING".

Then press ENTER.

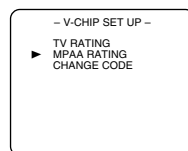

4 Select your desired item

Press Arrow (▲/▼) to point to your desired item.

Then press ENTER to select [BLOCK] or [VIEW].

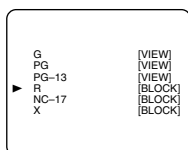

Selection	Rating Category Explanations
G	General Audience
PG	Parental Guidance suggested.
PG-13	Unsuitable for children under 13
R	Restricted; under 17 requires accompanying parent or adult guardian
NC-17	No one under 17 admitted
X	Mature audience only

- When you select the rating category and turn it [BLOCK], the higher rating will turn [BLOCK] automatically. Also, the lower rating will turn [VIEW] automatically.
- When you turn "G" to [VIEW], all ratings will turn to [VIEW] automatically.

5 Exit the V-Chip setting mode

Press SETUP on the remote control to return to original mode.

CHANGE ACCESS CODE

To change access code, follow the steps.

1 Select "V-CHIP SET UP"

Press SETUP on the remote control.

Press Arrow (▲/▼) to point to "V-CHIP SET UP".

Then press ENTER.

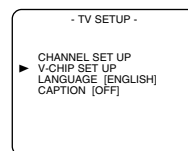

2 Enter 4-digit access code

Press the number buttons. The default code is 0000.

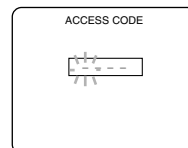

3 Select "CHANGE CODE"

Press Arrow (▲/▼) to point to "CHANGE CODE".

Then press ENTER.

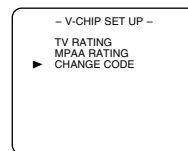

4 Enter 4-digit access code

Press the number buttons to enter your desired access code in the NEW CODE space. Then enter the same code in the CONFIRM CODE space. V-CHIP SET UP screen appear on the screen.

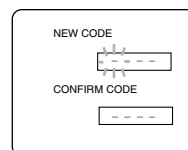

- If you enter wrong code, repeat step 4, making sure you enter the same new code exactly in the confirm code space.

5 Exit the V-Chip setting mode

Press SETUP on the remote control to return to original mode.

NOTE:

- If you unplug the power cord or power failure occurs, the changed access code will be lost and will return to default (0000). Change your access code again as necessary.

ABOUT THE DISCS

PLAYABLE DISCS

The following discs can be played back on this TV/DVD.

- DVD video
- DVD-R/RW*
- DVD+R/RW*
- Audio CD
- CD-R/RW*
- MP3*

* Depending on the types or the writing method of the medium some discs can not be played.

- Some DVD-R/RW, DVD+R/RW, or CD-R/RW discs made on personal computers or on DVD recorders may not be played back properly due to the factors such as scratches, dirt or special properties of the disc.
- Discs made on personal computers may not be played back properly due to the different environment or the settings of the application you use. We recommend always to use the standardized, rightly formatted discs. (Please contact the sales agency for more detail).

This TV/DVD conforms to the NTSC color system. You cannot play discs recorded in other color systems such as PAL or SECAM.

- Some discs include region codes as shown below.



- The number inside the symbol refers to a region of the world, and a disc encoded in a specific region format can only be played back on TV/DVD with the same region code.

The following discs cannot be played back on this TV/DVD.

- DVD with region codes other than 1 or ALL
- DVD-ROM
- DVD-RAM (Never play back, otherwise malfunction may result.)
- CD-ROM
- VSD
- CDV (Only plays back the audio part.)
- CD-G (Only plays back the sound.)
- CD-I (Never play back, otherwise malfunction may result.)
- SACD
- Photo CD (Never play back, otherwise malfunction may result.)
- Video CD (Never play back, otherwise malfunction may result.)

Any other discs without compatibility indications.

DISC TYPES

[DVD]

Data on a DVD is divided into sections called "titles" and then into subsections called "chapters", each of which is given a title or chapter number. Playback conditions are preset on some DVD video discs and these playback conditions take priority over user operations on this TV/DVD. If a function you selected does not run as desired, refer to the manual accompanying the disc.

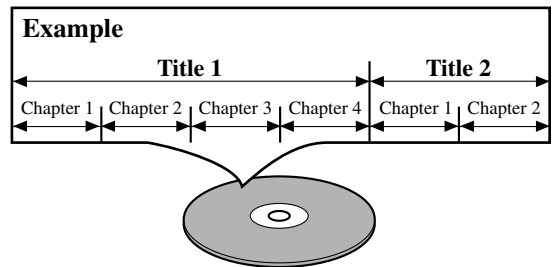

[AUDIO CD]

Data on an audio CD is divided into sections called "tracks", each of which is given a track number.

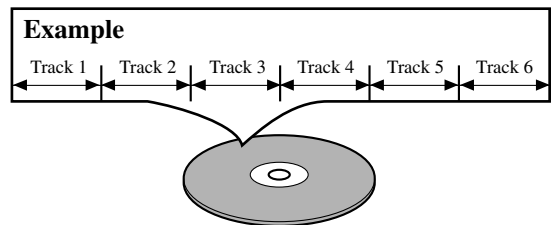

[MP3]

Data on an MP3 is divided into sections called "groups", and then into subsections called "tracks", each of which is given a group or track number.

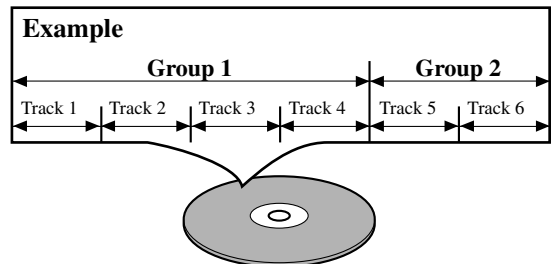

PLAYING A DISC

BASIC PLAYBACK

DVD-V CD MP3

Getting started

- Turn on the power of amplifier and any other components, if necessary.

1 Press POWER.

- The power will turn on.

2 Press OPEN/CLOSE to open disc loading tray.

3 Place the chosen disc in the tray, with the label facing up.

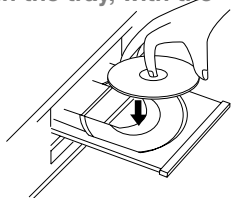

4 Press PLAY.

- The tray will close automatically and playback will then start from the first chapter or track of the disc. If the playback does not start automatically, press PLAY.
- When you playback a DVD which features a title menu, it may appear on the screen. In this case, refer to “TITLE MENU”.

5 Press STOP to stop playback.

NOTES

- When the DVD mode has been switched to the TV mode, the DVD mode shuts down first and then TV picture and sound appears in about 4 seconds. Similarly, when POWER is pressed to turn off in the DVD mode, this mode shuts down first and then the TV/DVD's power is turned off.
- A “prohibited icon” may appear at the top-right on the TV screen during operation, warning that a prohibited operation has been encountered by the DVD or the disc. 
- With DVDs that use titles for playback program signals, playback may start from the second title, or it may skip these titles.
- During the playback of a two layered disc, pictures may stop for a moment. This happens when the 1st layer switches to the 2nd layer. This is not a malfunction.

GENERAL FEATURES

DVD-V

DVD may contain menus to navigate the disc and access special features. Press appropriate number buttons or use Arrow (▲/▼/◀/▶) to highlight your selection in the DVD main menu and press ENTER to confirm.

NOTES

- Select DVD mode by pressing SELECT on the remote control. Then press PLAY or OPEN/CLOSE before you operate the DVD functions.
- Unless stated, all operations described are based on remote control use. Some operations can be carried out using the menu bar on the TV screen.

DISC MENU

DVD-V

1 Press DISC MENU on the remote control.

- The DVD main menu will appear.

2 If the feature is not available, symbol may appear on the TV screen.

3 If disc menu is available on the disc, audio language, subtitle options, chapters for the title and other options will appear for selection.

4 Press Arrow (▲/▼/◀/▶) to select an item and ENTER to confirm selection.

TITLE MENU

DVD-V

1 Press TITLE on the remote control.

- The title menu will appear.

2 If the feature is not available, symbol may appear on the TV screen.

3 Press Arrow (▲/▼/◀/▶) to select an item and ENTER to confirm selection.

CALLING UP A MENU SCREEN DURING PLAYBACK

- Press DISC MENU to call up the DVD menu.
- Press TITLE to call up the title menu.

NOTE

- Contents of menus and corresponding menu operations may vary between discs. Refer to the manual accompanying the disc for details.

RESUME

DVD-V CD MP3

- 1 During playback, press STOP.
 - Resume message will appear on the TV screen.
- 2 Press PLAY, playback will resume from the point at which playback was stopped.
 - To cancel resume, press STOP twice.
 - If TV/DVD is turned off, resume function will be cancelled.
 - For MP3, playback will resume from the beginning of the track at which playback was stopped.

PAUSE

DVD-V CD MP3

- 1 During playback, press PAUSE.
 - Playback will pause and sound will be muted.
- 2 To continue playback, press PLAY.

STEP BY STEP PLAYBACK

DVD-V

- 1 During playback, press PAUSE.
 - Playback will pause and sound will be muted.
- 2 The disc goes forward by one frame each time PAUSE is pressed.
- 3 To exit step by step playback, press PLAY.

FAST FORWARD/REVERSE SEARCH

DVD-V CD MP3

- 1 During playback, press FWD ►► or REV ◀◀.
 - “►► 1” or “◀◀ 1” appears on the screen.
- 2 To select another speed, repeat step1 until your required speed appears on the screen.
 - For DVDs, fast forward/reverse search speed is different depending on the disc. Approximate speed is 1(×2), 2(×8), 3(×50) and 4(×100).
 - For audio CDs, approximate speed is ×16.
 - For MP3, approximate speed is ×8
 - When you use buttons on the TV/DVD front panel, press and hold SKIP ►►/ SEARCH ►► or SKIP ◀◀/ SEARCH ◀◀ for a few seconds.
- 3 To return to normal playback, press PLAY.

SLOW FORWARD / SLOW REVERSE

DVD-V

- 1 During playback, press PAUSE.
- 2 Press FWD ►► or REV ◀◀.
 - “►► 1” or “◀◀ 1” appears on the screen.
- 3 To select another speed, repeat step2 until your required speed appears on the screen.
 - Slow forward or reverse speed varies with the disc. Approximate speed is 1(1/16), 2(1/8) and 3(1/2).
 - When you use buttons on the TV/DVD front panel, press and hold SKIP ►►/ SEARCH ►► or SKIP ◀◀/ SEARCH ◀◀ for a few seconds.
- 4 To return to normal playback, press PLAY.

SEARCH FUNCTION

TRACK SEARCH

CD

MP3

There are three ways to begin playback on an Audio CD and MP3 at a specific track.

Using the number buttons on the remote control

1 Press the number buttons to enter the desired track number.

- Playback will start at the selected track.
- For single digit tracks (1-9), press a single number (eg. track 3, press 3).
- To play track 26, press +10, 2, 6.

Using SEARCH MODE

1 Press SEARCH MODE.

- The Track search display appears.

2 Within 30 seconds, select a desired track number using the number buttons.

- For single digits press 0 first if the total track of the disc is more than 10 tracks.
- Playback will start at the selected track.

Using SKIP ◀◀▶▶

During playback, press SKIP ▶▶ to move the next track. Press it repeatedly to skip subsequent tracks. Press SKIP ◀◀ to go back to beginning of the current track. Press it repeatedly to go to the previous tracks.

- If SKIP is pressed while the playback is paused, the playback will be paused again after skipping to the next track.

NOTE

- SKIP ◀◀ ▶▶ are not available when playback is stopped.

TIME SEARCH

DVD-V

CD

1 During playback, press SEARCH MODE three times (CD: twice) to display the Time Search on the TV screen.

2 Within 30 seconds, enter a desired disc time using the number buttons.

- Playback will start at the specified time.
- Press CLEAR to erase the incorrect input.
- When there is no need to enter a number, “0” appears automatically. For example, “0 : 0 - : -” appears in the Time Search display if the total time of the disc is less than 10 minutes.

MARKER SETUP SCREEN

DVD-V

CD

Use markers to memorise your favorite places on a disc.

1 Press SEARCH MODE four times (CD: three times) during playback.

- The display screen and Markers will appear on the TV screen.

2 Press Arrow (◀/▶) to select 1, 2, 3, 4, 5, 6, 7, 8, 9, or 10 and ensure that “- - - - -” appears in the display.

3 When you reach the desired point, press ENTER.

- The title or track and elapsed playing time will appear in the TV screen.

4 To return to the Marker later, press SEARCH MODE four times (CD: three times) during playback and Arrow (◀/▶) to choose the desired marker, then press ENTER.

NOTES

- Opening the disc tray or turning off the power or selecting AC at step 2 and pressing ENTER will erase all Markers.
- To clear a marker, using Arrow (◀/▶), position the cursor on to the marker number to be cleared and press CLEAR.
- You can mark up to 10 points.

5 Press SEARCH MODE or RETURN to exit.

TITLE / CHAPTER SEARCH

DVD-V

1 Press SEARCH MODE once for the Chapter search, twice for the Title search during playback.

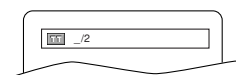

2 Enter the desired chapter/title number using the number buttons.

- Playback will start at the selected chapter or track.
- Press CLEAR to erase the incorrect input.
- For single digits press 0 first if the total track of the disc is more than 10 tracks.

SPECIAL PLAYBACK FUNCTION

REPEAT

REPEAT is available only during playback.

REPEAT TITLE / CHAPTER

DVD-V

To activate the repeat function, press REPEAT during playback.

- The repeat mode changes as described below every time you press the button.

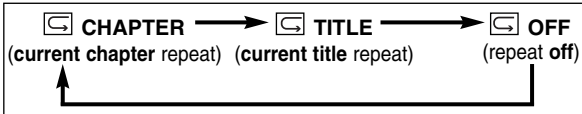

NOTES

- Repeat Title/Chapter is not available with some scenes.
- The REPEAT setting will be cleared when moving to other title or chapter.

REPEAT TRACK

CD

To activate the repeat function, press REPEAT during playback.

- The repeat mode changes as described below every time you press the button.



NOTES

- Repeat setting will be cleared when moving to other track.
- Repeat playback does not function during repeat A-B playback.

REPEAT A-B

DVD-V CD

1 Press REPEAT A-B at your chosen starting point.

- A- appears briefly on the TV screen.

2 Press REPEAT A-B again at your chosen end point.

- A-B appears briefly on the TV screen and the repeat sequence begins.

3 To exit the sequence, press REPEAT A-B.

NOTES

- The repeat A-B section can only be set within the current title (for DVDs) or current track (for audio CDs).
- Repeat A-B is not available with some scenes in DVD.
- To cancel the A point which was set, press CLEAR.
- Repeat A-B playback does not function during title, chapter, track or all repeat playback.

PROGRAM

CD

You may determine the order in which tracks will play.

1 In stop mode, press MODE.

- The PROGRAM screen will appear.

2 Press Arrow (▲/▼) to select a track, then press ENTER.

- Press CLEAR to erase the most recently entered program.

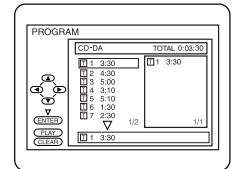

3 Repeat step 2 until you have selected all the tracks you want to play in the program.

4 Press PLAY to play the programmed tracks.

NOTES

- While the program is being played back, the STOP works as follows.
- Press STOP once and then PLAY again, playback will restart from the point where STOP was pressed. (Program continued)
- Press STOP twice and then PLAY again, playback will restart from the track in the usual way. (Program cleared)
- Up to 99 programs can be entered.
- To erase all programs at once, select ALL CLEAR at the bottom of the list at Step 2.
- If you like to repeat the current track in the program, press REPEAT repeatedly until TRACK appears during playback. If you like to repeat the entire program press REPEAT repeatedly until ALL appears during playback.

RANDOM PLAYBACK

CD

This shuffles the playing order of tracks instead of playback in the sequence.

1 In stop mode, press MODE twice.

- RANDOM screen appears.

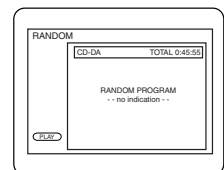

2 Press PLAY to start random playback.

NOTE

- If you like to repeat the current track in the random selection, press REPEAT repeatedly until TRACK appears during playback. If you like to repeat the entire random selection press REPEAT repeatedly until ALL appears during playback.

PLAYING A MP3 DISC

MP3 PLAYBACK

MP3

When a CD with MP3 files is in the TV/DVD, press DISC MENU to call up the MP3 menu on the TV screen.

1 In stop mode, press Arrow (▲/▼) to select the desired group or track.

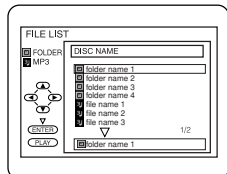

- If a group is selected, press ► or ENTER to go on to the track selection screen. Press Arrow (▲/▼) to choose a track, then press ENTER.
- If a track is selected, press ENTER to start playing tracks. Starting from the one you've just chosen the subsequent tracks will be played.
- Press TITLE to return to the first item.

2 Press STOP to stop playback.

NOTES

- Folders are known as Groups; files are known as Tracks.
- MP3 files are accompanied by  icon.
- Maximum of 255 folders can be recognized.
- Maximum of 512 files can be recognized.
- Up to 8 hierarchies can be created.

This TV/DVD recommends the use of files recorded at the below specifications:

- Sampling frequency: 44.1kHz or 48kHz
- Constant bit rate: 112kbps ~ 320kbps.

REPEAT

MP3

REPEAT is available only during playback.

To activate the repeat function, press REPEAT during playback.

- The repeat mode changes as described below every time you press the button.

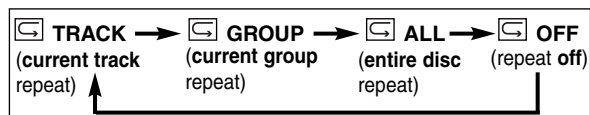

NOTE

- Repeat setting will be cleared when moving to other track.

PROGRAM

MP3

This feature allows you to program an MP3 disc to play in a desired sequence.

1 In stop mode, press MODE.

- The PROGRAM screen will appear.

2 Select a desired track using Arrow (▲/▼/◀/▶). Then press ENTER.

- Press ► when you want to go to the next hierarchy.
- Press ◀ when you want to go back to the previous hierarchy.
- Press CLEAR to erase the most recently entered program.

3 Repeat step 2 until you have selected all the tracks you want to play in the program.

4 Press PLAY to start programmed playback.

NOTES

- While the program is being played back, the STOP works as follows.
- Press STOP once and then PLAY again, playback will restart from the point where STOP was pressed. (Program continued)
- Press STOP twice and then PLAY again, playback will restart from the track in the usual way. (Program cleared)
- To erase all programs at once, select ALL CLEAR at the bottom of the list at Step2.

RANDOM PLAYBACK

MP3

1 In stop mode, press MODE twice.

- RANDOM screen appears.

2 Press PLAY to start random playback.

CHANGING THE SETTINGS

SUBTITLE LANGUAGE

DVD-V

The TV/DVD allows you to select a language for subtitles during DVD disc (if available) playback.

- 1 Press **SUBTITLE** during playback.
 - 2 Press **SUBTITLE** repeatedly to select your desired subtitle language.
- The subtitle language will be displayed on the display bar at the top of the screen.
- 3 To turn off subtitles, press **SUBTITLE** repeatedly until **OFF** appears.

NOTES

- Some discs allow audio language setting/subtitle language setting on the disc menu. (Operation varies between discs, so refer to the manual accompanying the disc.)
- If the desired language is not shown after pressing **SUBTITLE** several times, the disc does not have subtitles in that language.
- If you choose a Language that has a 3 letter language code, the code will be displayed every time you change the Subtitle language setting. If you choose any other languages, '---' will be displayed instead. (Refer to page 27.)

AUDIO LANGUAGE

DVD-V

The TV/DVD allows you to select a language during DVD disc (if multi languages are available) playback.

- 1 Press **AUDIO** during playback.
- 2 Press **AUDIO** repeatedly to select your desired language.

NOTE

- Pressing **AUDIO** may not work on some DVDs with multiple audio languages (e.g. DVDs which allow audio language setting on the disc menu).

STEREO SOUND MODE

CD

- 1 Press **AUDIO** repeatedly during playback to select between **STEREO**, **L-CH** or **R-CH**.
- **STEREO** - both right and left channels are active (stereo)
L-CH - only left channel is active
R-CH - only right channel is active
- ### NOTE
- If the Virtual Surround setting is **ON**, the sound mode will be fixed to **STEREO** and can not be changed.

CAMERA ANGLE

DVD-V

Some DVD discs contain scenes which have been shot simultaneously from various angles. You can change the camera angle when the () icon appears on the screen.

- 1 Press **ANGLE** during playback.
- The selected angle will be displayed on the display bar at the top of the screen.
- 2 Press **ANGLE** repeatedly to select your desired angle.

BLACK LEVEL SETTING

DVD-V

Adjust the Black Level Settings to make the black parts of the picture brighter.

- 1 Press **MODE** during playback.

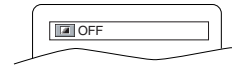

- 2 Press **ENTER** to switch **ON/OFF**.

ON: Makes the dark parts brighter.
OFF: Shows the original picture as recorded.

- 3 Press **MODE** twice or **RETURN** to exit.

NOTE

- The setting will be saved even if the TV/DVD is turned off.

VIRTUAL SURROUND

DVD-V

CD

MP3

You can enjoy surround-sound effect over two speakers on this TV/DVD.

- 1 Press **V.SURR** once or **MODE** twice (CD/MP3: once) during playback.

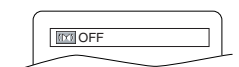

- 2 Press **ENTER** to set it 1 (Natural effect) or 2 (Emphasized effect) or **OFF**.

- 3 Press **V.SURR** or **MODE** or **RETURN** to exit.

NOTE (for CD play only)

- Virtual Surround will not be effective if the sound mode is set to something other than **STEREO**.

THE ON-SCREEN INFORMATION

DVD-V CD MP3

You can check the information about the current disc by pressing DISPLAY on the remote control.

For DVD-Vs

1 Press DISPLAY during playback to show current Chapter.

- The elapsed and remaining playing time of the current chapter will be displayed.

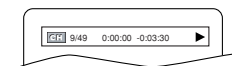

2 Press DISPLAY again to show current Title.

- The elapsed and remaining playing time of the current title will be displayed.

3 Press DISPLAY again.

- The BIT RATE and the current repeat setting will be displayed.
- If you are playing a dual layered disc, the layer number will also be displayed (L0: Layer 0 is playing. L1: Layer 1 is playing).

4 Press DISPLAY again to exit the display.

For audio CDs

1 Press DISPLAY during playback to show the current Track.

- The elapsed and remaining playing time of the current track will be displayed.

2 Press DISPLAY again to show current Total Track.

- The elapsed and remaining playing time of the current total track will be displayed.

3 Press DISPLAY again to exit the display.

For MP3

1 Press DISPLAY during playback.

- The name of the file currently in play will be displayed.

2 Press DISPLAY again to show the track number, the elapsed time, the repeat status and the playback status at the top of the screen.

-  will be displayed when repeat play has been selected.

 T - indicates Track repeat

 G - indicates Group (folder) repeat

 A - indicates Disc repeat

3 Press DISPLAY again to exit the display.

CHANGING THE DVD SETUP ITEMS

LANGUAGE SETTING

DVD-V

Language options are not available with some discs.

1 Press **SETUP** twice in **STOP** mode so that the **DVD SETUP** menu appears.

- If the menu does not appear, press **PLAY**, **STOP**, then **SETUP** twice.

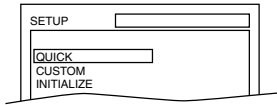

2 Press **Arrow ▼** to select “**CUSTOM**”, then press **ENTER**.

- **CUSTOM** mode will appear.

3 Press **Arrow (▲/▼)** to select “**LANGUAGE**”, then press **ENTER** to confirm.

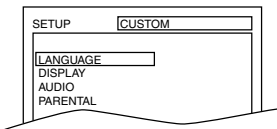

4 Press **Arrow (▲/▼)** to select the next items, then press **ENTER**.

AUDIO: Sets the audio language.

SUBTITLE: Sets the subtitle language.

DISC MENU: Sets the language for DVD menu.

5 Press **Arrow (▲/▼)** to select a setting, then press **ENTER**.

- If **OTHER** is selected on the **AUDIO**, **SUBTITLE** or **DISC MENU** screen, press four-digit number to enter the code for the desired language. (Refer to the language code list.)
- Only the languages supported by the disc can be selected.

6 Press **SETUP** to exit.

NOTE

- Language Setting for Audio and Subtitle is not available with some discs. Then use the **AUDIO** and the **SUBTITLE** button. Details are on page 25.

TO CHANGE THE ON-SCREEN MENUS

You can access the TV **SETUP** menu by pressing **SETUP** from the DVD mode. Refer to “Selecting the Language” on page 13 to changing the on-screen menus.

Language	Code	Language	Code
	A-B		L-N
Abkhazian	4748	Laothian	5861
Afar	4747	Latin	5847
Afrikaans	4752	Latvian;Lettish	5868
Albanian	6563	Lingala	5860
Amharic	4759	Lithuanian	5866
Arabic	4764	Macedonian	5957
Armenian	5471	Malagasy	5953
Assamese	4765	Malay	5965
Aymara	4771	Malayalam	5958
Azerbaijani	4772	Maltese	5966
Bashkir	4847	Maori	5955
Basque	5167	Marathi	5964
Bengali;Bangla	4860	Moldavian	5961
Bhutani	5072	Mongolian	5960
Bihari	4854	Nauru	6047
Bislama	4855	Nepali	6051
Breton	4864	Norwegian [NOR]	6061
Bulgarian	4853		O-R
Burmese	5971	Occitan	6149
Byelorussian	4851	Oriya	6164
	C-E	Oromo(Afan)	6159
Cambodian	5759	Panjabi	6247
Catalan	4947	Pashto;Pusho	6265
Chinese [CHI]	7254	Persian	5247
Corsican	4961	Polish	6258
Croatian	5464	Portuguese [POR]	6266
Czech	4965	Quechua	6367
Danish [DAN]	5047	Rhaeto-Romance	6459
Dutch [DUT]	6058	Romanian [RUM]	6461
English [ENG]	5160	Russian [RUS]	6467
Esperanto	5161		S
Estonian	5166	Samoa	6559
	F-H	Sangho	6553
Faroese	5261	Sanskrit	6547
Fiji	5256	Scots Gaelic	5350
Finnish [FIN]	5255	Serbian	6564
French [FRE]	5264	Serbo-Croatian	6554
Frisian	5271	Sesotho	6566
Galician	5358	Setswana	6660
Georgian	5747	Shona	6560
German [GER]	5051	Sindhi	6550
Greek [GRE]	5158	Singhalese	6555
Greenlandic	5758	Siswat	6565
Guarani	5360	Slovak	6557
Gujarati	5367	Slovenian	6558
Hausa	5447	Somali	6561
Hebrew	5569	Spanish [SPA]	5165
Hindi	5455	Sundanese	6567
Hungarian [HUN]	5467	Swahili	6569
	I-K	Swedish [SWE]	6568
Icelandic [ICE]	5565		T
Indonesian	5560	Tagalog	6658
Interlingua	5547	Tajik	6653
Interlingue	5551	Tamil	6647
Inupiak	5557	Tatar	6666
Irish [IRI]	5347	Telugu	6651
Italian [ITA]	5566	Thai	6654
Japanese [JPN]	5647	Tibetan	4861
Javanese	5669	Tigrinya	6655
Kannada	5760	Tonga	6661
Kashmiri	5765	Tsonga	6665
Kazakh	5757	Turkish [TUR]	6664
Kinyarwanda	6469	Turkmen	6657
Kirghiz	5771	Twi	6669
Kirundi	6460		U-Z
Korean [KOR]	5761	Ukrainian	6757
Kurdish	5767	Urdu	6764
		Uzbek	6772
		Vietnamese	6855
		Volapuk	6861
		Welsh	4971
		Wolof	6961
		Xhosa	7054
		Yiddish	5655
		Yoruba	7161
		Zulu	7267

If you choose a Language that has a 3 letter language code, the code will be displayed every time you change the Audio or Subtitle language setting on page 25. If you choose any other languages, ‘---’ will be displayed instead. (3 letter language code is written in bracket.)

DISPLAY SETTING

DVD-V

You can change certain aspects of the DVD display screens and on-screen messages on the TV screen.

1 Press **SETUP** twice in **STOP** mode so that the **DVD SETUP** menu appears.

- If the menu does not appear, press **PLAY**, **STOP**, then **SETUP** twice.

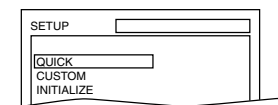

2 Press **Arrow ▼** to select “**CUSTOM**”, then press **ENTER**.

- **CUSTOM** mode will appear.

3 Press **Arrow (▲/▼)** to select “**DISPLAY**”, then press **ENTER** to confirm.

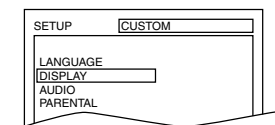

4 Press **Arrow (▲/▼)** to select the below items, then press **ENTER**.

TV MODE: **QUICK**

- Press **Arrow (▲/▼)** for an item selection, then press **ENTER**.
- Select **4:3 LETTER BOX** for black bars to appear on top and bottom of the screen.
- Select **4:3 PAN & SCAN** for a full height picture with both sides trimmed.
- The default setting is **4:3 LETTER BOX**.

STILL MODE:

- Press **Arrow (▲/▼)** for an item selection, then press **ENTER**.
- Select “**AUTO**” usually.
- If you select “**FIELD**”, the picture in the still mode will be stabilized.
- If you select “**FRAME**”, the picture in the still mode will be highly defined.

ANGLE ICON:

- Press **ENTER** repeatedly to turn Angle icon **ON** or **OFF**.
- The default setting is **ON**.

AUTO POWER OFF:

- Press **ENTER** repeatedly to turn Auto Power off **ON** or **OFF**.
- The default setting is **ON** and it will turn the TV/DVD off automatically after 15 minutes of no use.

5 Press **SETUP** to exit.

AUDIO SETTINGS

DVD-V

Choose the appropriate Audio settings for your equipment as it only affects during the playback of DVD discs.

1 Press **SETUP** twice in **STOP** mode so that the **DVD SETUP** menu appears.

- If the menu does not appear, press **PLAY**, **STOP**, then **SETUP** twice.

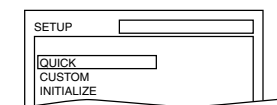

2 Press **Arrow ▼** to select “**CUSTOM**”, then press **ENTER**.

- **CUSTOM** mode will appear.

3 Press **Arrow (▲/▼)** to select “**AUDIO**”, then press **ENTER** to confirm.

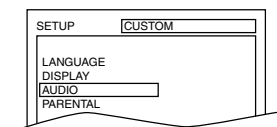

4 Press **Arrow (▲/▼)** to select the below items, then press **ENTER**.

DRC (Dynamic Range Control):

- To compress the range of sound volume.
- The default setting is **ON**.

DOWN SAMPLING:

- Set to **ON** when outputting in 48 kHz.
- The default setting is **ON**.

When playing disc with copyright Protection

- If you select **OFF**, copyright protection will be activated and sound will be down sampled at 48kHz.

DOLBY DIGITAL: **QUICK**

Set to **On** when the unit is connected to a Dolby Digital Decoder.

(**ON:** Output by Dolby Digital)

(**OFF:** Convert the Dolby Digital to PCM (2 channel stereo))

- The default setting is **ON**.

5 Press **SETUP** to exit.

PARENTAL CONTROL

DVD-V

Parental Control limits the disc viewing that exceed your settings. (with a password or playback will stop.) This feature allows you to prevent discs with alternative scenes from being played by your children.

PARENTAL LEVEL

Parental Level allows you to set the rating level of your DVD discs. Playback will stop if the disc's ratings exceed the level you set.

- 1 Press **SETUP** twice in **STOP** mode so that the **QUICK SETUP** menu appears.
- If the menu does not appear, press **PLAY**, **STOP**, then **SETUP** twice.

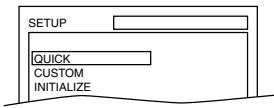

- 2 Press **Arrow ▼** to select "**CUSTOM**", then press **ENTER**.

- 3 Press **Arrow (▲/▼)** to select "**PARENTAL**", then press **ENTER**.

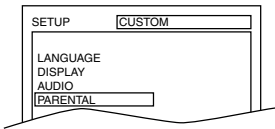

- 4 Enter your four-digit password then press **ENTER**.

- 5 Press **Arrow (▲/▼)** to select **PARENTAL LEVEL**, then press **ENTER**.

- 6 Press **Arrow (▲/▼)** to select the desired level, then press **ENTER**.

- 7 Press **SETUP** to exit

NOTES

- When doing this for the first time, enter any 4 digits. (except for 4737) That number will be used as the password from the second time onward.
- To change the password, press **Arrow (▲/▼)** to select **CHANGE** at step 5, then press **ENTER**. Enter the four-digit password, then press **ENTER**.
- With some DVDs, it may be difficult to find if they are compatible with parental lock. Be sure to check if the parental lock function operates in the way that you have set.
- Record the password in case you forget it.

CONTROL LEVELS

- **ALL**

All parental lock is cancelled.

- **Level 8**

DVD software of any grade (adult/general/children) can be played back.

- **Levels 7 to 2**

Only DVD software intended for general use and children can be played back.

- **Level 1**

Only DVD software intended for children can be played back, with those intended for adult and general use is prohibited.

IF YOU FORGET THE PASSWORD

- 1 Press **4, 7, 3, 7** at step 4. Then enter your new password.

- Password will be cleared and parental level will be set to **ALL**.

- 2 Follow Steps [5]-[7] again.

INITIALIZE

This allows you to return all selections of **SETUP** (except for **PARENTAL**) to their default settings.

- 1 Press **SETUP** twice in **STOP** mode so that the **INITIALIZE** menu appears.

- 2 Press **Arrow (▲/▼)** to select "**INITIALIZE**", then press **ENTER**.

- 3 Select "**YES**", then press **ENTER** twice. All the settings (except for "**PARENTAL**") will be cleared.

- To cancel the initialization, select "**NO**".

- 4 Press **SETUP** to exit.

TROUBLESHOOTING GUIDE

If the TV/DVD does not perform properly when operated as instructed in this Owner's Manual, check the TV/DVD, consulting the following checklist.

Problem	Corrective Action
No power	<ul style="list-style-type: none"> • Make sure the power plug is connected to an AC outlet. • Make sure the power is turned on.
The TV/DVD does not respond to the remote control.	<ul style="list-style-type: none"> • Check if the power plug is connected to an AC outlet. • Check the batteries in the remote control. • Aim the remote control directly at the remote sensor. If necessary, remove all the obstacles between the sensor and the remote. • You have to be within 23 feet of the TV/DVD. • Check if the correct mode is selected. If not switch the mode by pressing SELECT on the remote control, whichever you need.

TV Mode

Problem	Corrective Action
No Picture or Sound	<ul style="list-style-type: none"> • Try a new channel, if OK, then possible station trouble. • Make sure the power is turned on. • Press SELECT on the remote control to select TV mode. Then try other TV feature. • Is antenna connected to terminal on the back of the set? • If outside antenna is being used, check for broken wire.
Bars On Screen	<ul style="list-style-type: none"> • If outside antenna is being used, check for broken wire. • Check for local interference.
Picture Distorted or Blurred	<ul style="list-style-type: none"> • Try a new channel, if OK, then possible station trouble. • If outside antenna is being used, check for broken wire.
Picture Rolls Vertically Lines or Streaks in Picture	<ul style="list-style-type: none"> • Try a new channel, if OK, then possible station trouble. • If outside antenna is being used, check for broken wire. • Check for local interference.
No Color	<ul style="list-style-type: none"> • Try a new channel, if OK, then possible station trouble. • Is antenna connected to terminal on the back of the set? • If outside antenna is being used, check for broken wire. • Adjust COLOR control.
Poor Reception on Some Channels Ghosts in Picture	<ul style="list-style-type: none"> • Try a new channel, if OK, then possible station trouble. • Is antenna connected to terminal on the back of the set? • If outside antenna is being used, check for broken wire. • Check for local interference.
Weak Picture	<ul style="list-style-type: none"> • Try a new channel, if OK, then possible station trouble. • Is antenna connected to terminal on the back of the set? • If outside antenna is being used, check for broken wire. • Adjust CONTRAST & BRIGHT control.
Sound OK, Picture Poor	<ul style="list-style-type: none"> • Try a new channel, if OK, then possible station trouble. • Is antenna connected to terminal on the back of the set? • If outside antenna is being used, check for broken wire. • Check for local interference. • Adjust CONTRAST & BRIGHT control.
Picture OK, Sound Poor	<ul style="list-style-type: none"> • Try a new channel, if OK, then possible station trouble. • Check for local interference.
Different color marks on screen	<ul style="list-style-type: none"> • Magnetism from nearby appliances and geomagnetism might affect the color of the TV picture. Move the TV/DVD away from the appliances, the TV/DVD can repair itself automatically. If you want to repair immediately, unplug the TV/DVD power cord, then plug it in again 30 minutes or so later.

Closed Caption Problem	Possible Remedy
My TV/DVD is showing captions that are misspelled.	<ul style="list-style-type: none"> You are watching a live broadcast and spelling errors made by the closed captioning production company may pass through uncorrected. A prerecorded program will not show any misspelled words because of the normal time available for editing the captions.
My TV/DVD will not show the text in its entirety or there is a delay of what is being said.	<ul style="list-style-type: none"> Captions that are delayed a few seconds behind the actual dialogue are common for live broadcast. Most captioning production companies can display a dialogue to a maximum of 220 words per minute. If a dialogue exceeds that rate, selective editing is used to insure that the captions remain up-to-date with the current TV screen dialogue.
My captions are scrambled with white boxes on the TV screen.	<ul style="list-style-type: none"> Interference caused by building, power lines, thunderstorms, etc. may cause scrambled or incomplete captions to appear.
My program guide listed a TV show as being closed captioned but none of the captions were displayed.	<ul style="list-style-type: none"> Broadcasters may at times use a time compression process to the actual program so that additional advertising time can be given. Since the decoder cannot read the compressed information, captions will be lost.
My TV/DVD screen shows a black box on certain channels.	<ul style="list-style-type: none"> You are in the TEXT mode. Select CAPTION mode or CAPTION [OFF].

DVD Mode

Problem	Corrective Action
No picture	<ul style="list-style-type: none"> Insert a correct video disc that plays on this TV/DVD. Press SELECT on the remote control to select DVD mode. Next, press PLAY or OPEN/CLOSE. Then, try other DVD feature.
Disc cannot be played	<ul style="list-style-type: none"> Insert the disc. Clean the disc. Place the disc correctly, with the label side up. Cancel the parental lock or change the control level.
No sound	<ul style="list-style-type: none"> Connect the audio cables firmly. Turn the power of the audio component on. Correct the audio output settings. Correct the input settings on the audio component.
No DTS audio is output	<ul style="list-style-type: none"> This TV/DVD does not support DTS audio. This is not a malfunction.
Distorted picture	<ul style="list-style-type: none"> There are some cases where pictures may be slightly distorted, which are not a sign of a malfunction. Although pictures may stop for a moment, this is not a malfunction.
Audio or subtitle language does not match the set up	<ul style="list-style-type: none"> The selected language is not available for audio or subtitles on the DVD. <p>This is not a malfunction</p>
The camera angle cannot be changed	<ul style="list-style-type: none"> The DVD does not contain sequences recorded from different camera angles. This is not a malfunction
Audio or subtitle language cannot be changed	<ul style="list-style-type: none"> The DVD does not contain audio source or subtitles in the selected language. This is not a malfunction.
“Prohibited icon” appears on the screen, prohibiting an operation	<ul style="list-style-type: none"> That operation is prohibited by the TV/DVD or the disc. <p>This is not a malfunction.</p>
CD sound dropout No CD reproduction DVD picture dropout DVD picture freeze DVD picture in mosaic No DVD reproduction	<ul style="list-style-type: none"> Scratched disc. Replace the disc with an unscratched one.

NOTES:

- Some functions are not available in specific modes, but this is not a malfunction. Read the description in this Owner’s Manual for details on correct operations.
- Playback from a desired track and random playback are not available during program playback.

MAINTENANCE

CABINET CLEANING

- Wipe the front panel and other exterior surfaces of the TV/DVD with a soft cloth immersed in luke-warm water and wrung dry.
- Never use a solvent or alcohol. Do not spray insecticide liquid near the TV/DVD. Such chemicals may cause damage and discoloration to the exposed surfaces.

SERVICING

- Should your TV/DVD become inoperative, do not try to correct the problem by yourself. There are no user-serviceable parts inside. Turn off, unplug the power cord and please call our help line at 1-800-968-3429, to locate an Authorized Service Center.

IF THE LASER OPTICAL PICKUP UNIT IS DIRTY

- If the TV/DVD still does not perform properly when it is operated while referring to the relevant sections and to "TROUBLESHOOTING GUIDE" in this Owner's Manual, the laser optical pickup unit may be dirty. Consult your dealer or an Authorized Service Center for inspection and cleaning of the laser optical pickup unit.

DISC HANDLING

- Use discs which have the following logos on them. (Optical audio digital discs.)



- Handle the discs so that fingerprints and dust do not adhere to the surfaces of the discs.

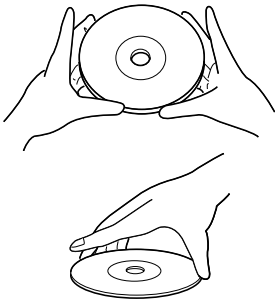

- Always store the disc in its protective case when it is not used.

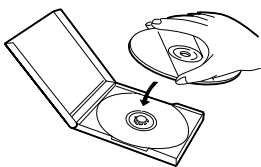

- To clean-off, use a soft cloth.
- Do not use a hard cloth since this will mar the disc.
- Wipe the disc in a straight line from center to edge.
- Never wipe with a circular motion.
- Do not use detergent or abrasive cleaning agents.

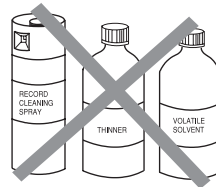
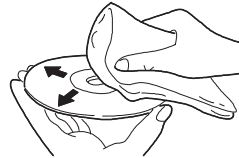

SPECIFICATIONS

GENERAL SPECIFICATIONS

TV

CRT :	13 inch in-line gun, 90° deflection tube
Television system:	NTSC-M TV Standard
Closed caption system:	§15.119/FCC
Channel coverage:	
VHF:	2 ~ 13
UHF:	14 ~ 69
CATV:	2 ~13, A ~ W, W+1 ~ W+84, A-5 ~ A-1, 5A
Tuning System:	181 channel frequency synthesized tuning system
Channel access:	Direct access keyboard, programmable scan and up/down

DVD

Discs:	DVD video, Audio CD
Output signal format:	NTSC color

ELECTRICAL SPECIFICATIONS

Sound output: 2 speakers, 1W, 8 ohm

OTHER SPECIFICATIONS

Terminals

Antenna input:	VHF/UHF/CATV 75 ohm unbalanced (F-type)
Video input:	RCA connector × 1
Audio L/R input:	RCA connector × 2
Headphone:	1/8" stereo (3.5 mm)
Coaxial digital audio output (only DVD):	One pin jack, 500m Vpp (75 ohm)
Remote control:	Digital encoded infrared light system
Operating temperature:	5°C to 40°C (41°F~104°F)
Power requirements:	AC 120V, 60Hz
Power consumption (Maximum) :	65W
Dimensions :	H:15-13/16"(402mm) W:15-3/16"(386mm) D:14-13/16"(376mm)
Weight :	21.6lbs(9.8kg)

- Designs and specifications are subject to change without notice.
- If there is a discrepancy between languages, the default language will be English.

INDICE

■ CONTROLES DE OPERACIÓN Y FUNCIONES	34
PANEL FRONTAL DEL TELEVISOR/DVD	34
MANDO A DISTANCIA	34
VISTA POSTERIOR	34
PARA INSERTAR LAS PILAS	35
■ PREPARACIÓN PARA LA UTILIZACIÓN	35
CONEXIONES DE ANTENA/CABLE	35
CONEXIÓN A TOMAS DE ENTRADA EXTERNA	36
CONEXIÓN A UN AMPLIFICADOR EQUIPADO CON TOMAS DE ENTRADA DIGITAL, PLATINA MD O PLATINA DAT (Para DVD)	36
CONEXIONA UN DECODIFICADOR DOLBY DIGITAL (Para DVD)	37
TV SECTION	
■ PREPARACIÓN PARA LA UTILIZACIÓN	37
SELECCIÓN DE IDIOMA	37
AJUSTE DE CANAL	38
DVD SECTION	
■ REPRODUCCIÓN DE UN DVD DE VÍDEO O UN CD DE AUDIO	38
REPRODUCCION BASICA	38

CONTROLES DE OPERACIÓN Y FUNCIONES

PANEL FRONTAL DEL TELEVISOR/DVD

Consulte la figura 1 de la página 8

MANDO A DISTANCIA

Consulte la figura 2 de la página 8

VISTA POSTERIOR

Consulte la figura 3 de la página 9

- 1. Bandeja de carga del disco**
- 2. Toma de entrada VIDEO**
Conecte aquí la toma de salida de vídeo de una videocámara o de una videograbadora.
- 3. Tomas de entrada AUDIO L/R**
Conecte aquí las tomas de salida de audio de una videocámara o de una videograbadora.
- 4. Botón POWER**
Púlselo para conectar y desconectar la alimentación.
- 5. Botones VOLUME ▲/▼(VOL.▲/▼)**
Púlselos para controlar el nivel del volumen para el DVD y el televisor.
- 6. Botones CHANNEL ▲/▼(CH.▲/▼)**
Púlselo para seleccionar el canal memorizado.
Púlselo para cambiar a un modo de televisor cuando esta en el modo de DVD.
- 7. Ventanilla del sensor del mando a distancia**
- 8. Botón STOP**
Detiene la operación del disco.

9. Botón SKIP ◀◀

Reproduce desde el inicio del capítulo o canción actual.

Botón SEARCH (REV) ◀◀ (panel delantero)

Durante la reproducción o en el modo de pausa, mantenga presionado el botón durante unos segundos para cambiar la velocidad de reproducción hacia atrás.

10. Botón PLAY

Inicia la reproducción del contenido del disco.
Púlselo para cambiar a un modo de DVD cuando esta en el modo de televisor.

11. Botón SKIP ▶▶

Reproduce desde el inicio del siguiente capítulo o canción.

Botón SEARCH (FWD) ▶▶ (panel delantero)

Durante la reproducción o en el modo de pausa, mantenga presionado el botón durante unos segundos para cambiar la velocidad de reproducción en avance.

12. Botón PAUSE

Hace una pausa en la operación del disco.

13. Botón OPEN/CLOSE

Púlselo para insertar discos en la bandeja o retirarlos de ella.

14. Toma HEADPHONE

Para conectar auriculares (no suministrados) y escuchar en privado.

15. Botón MODE

Activa el modo de reproducción programada o el modo de reproducción aleatoria cuando se reproducen CDs o MP3.

16. Botones de números

Modo del televisor:

Pulse dos dígitos para tener acceso directamente al canal deseado.

Recuerde pulsar "0" antes de elegir un canal de un solo dígito.

Botón +100

Púlselo para seleccionar canales de televisión por cable cuyo número sea igual o superior al 100.

Modo DVD:

Púlselo para introducir el número deseado.

Botón +10

Púlselo para introducir los números deseados cuyo número sea igual o superior al 10.

17. Botón SLEEP

Pulse el botón SLEEP para visualizar el temporizador para dormir y activar la función. La hora de apagado puede determinarse por el número de veces que usted pulsa el botón. (0, 30, 60, 90 o 120 minutos)

18. Botón REV ◀◀

Presione para ver la imagen en DVD en retroceso rápido. Presione PAUSE y presione este botón para empezar la reproducción en cámara lenta. Presione repetidamente este botón para cambiar la velocidad en avance de la cámara lenta.

Botón FWD ▶▶

Presione para avanzar rápidamente en el disco. Presione PAUSE y presione este botón para empezar la reproducción en cámara lenta. Presione repetidamente este botón para cambiar la velocidad de avance de la cámara lenta.

19. Botón V.SURR

Púlselo para activar/desactivar el envolvente virtual.

20. Botón SETUP

Púlselo para activar o salir del modo de menús de televisor o preparación de DVD.

21. Botón TITLE

Visualiza el menú de títulos.

22. Botón CLEAR

Repone un ajuste.

23. Botón DISPLAY

Modo del televisor:

Púlselo para visualizar el número del canal en la pantalla. Si lo pulsa de nuevo, el número del canal desaparecerá.

Modo de DVD:

Visualiza el estado actual en la pantalla del televisor con fines de comprobación.

24. Botón SEARCH MODE

Púlselo para localizar un punto deseado.

25. Botón AUDIO

Púlselo para seleccionar un idioma de audio o un modo de sonido deseado.

26. Botón SUBTITLE

Púlselo para seleccionar un idioma de subtítulos deseado.

27. Botón REPEAT

Repite la reproducción del disco, título, capítulo o pista actual.

28. Botón ANGLE

Púlselo para cambiar el ángulo de la cámara y ver, desde un ángulo diferente, la secuencia que está siendo reproducida.

29. Botón A-B REPEAT

Repite la reproducción de una sección seleccionada.

30. Botón RETURN

Vuelve a la operación anterior en el modo de instalación del DVD.

31. Botón ENTER

Púlselo para establecer un ajuste.

32. Botones de flechas

Modo de televisor:

Púlselo para seleccionar un modo de ajuste desde el menú que aparece en la pantalla del televisor. Púlselo para seleccionar o ajustar desde un menú particular.

Modo de DVD:

Se utiliza cuando se hacen ajustes mientras se observa la visualización en una pantalla de televisor.

33. Botón DISC MENU

Visualiza menús en el DVD.

34. Botón SELECT

Púlselo para cambiar a un modo de televisor, modo de entrada externa o modo de DVD.

NOTA: Cuando seleccione el modo DVD con este botón, pulse primero PLAY u OPEN/CLOSE. De lo contrario, las funciones del DVD no se activarán.

35. Botón MUTE

Pulse el botón MUTE para apagar el sonido de un programa de TV. (La visualización del nivel del sonido cambia de ROJO CLARO a AZUL CLARO.) Pulse de nuevo el botón MUTE o el botón VOL Δ o ∇ para restaurar el sonido.

36. Botón PICTURE

Presione para entrar en el modo de ajuste de imagen.

37. Cable de alimentación Conéctelo a una toma de CA convencional (120 V/60 Hz).

NOTA: Retire el cable de alimentación del gancho para evitar romperlo antes de conectarlo a una toma de CA convencional.

38. Toma de salida de audio digital COAXIAL (DVD Audio solamente)

Conéctela a la entrada digital de un amplificador o decodificador externo.

39. Toma de entrada ANT.

Conéctela a una antena, sistema de televisión por cable o sistema de satélite.

PARA INSERTAR LAS PILAS

- 1) Abra la cubierta del compartimiento de las pilas empujando la cubierta del mando a distancia en el sentido de la flecha.
- 2) Inserte 2 pilas "AA" en el compartimiento de las pilas, en el sentido indicado por las marcas de polaridad (+/-).
- 3) Vuelva a poner la cubierta.

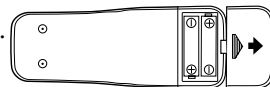

NOTAS:

- No mezcle pilas alcalinas y de manganeso.
- No mezcle pilas viejas y nuevas.

PREPARACIÓN PARA LA UTILIZACIÓN

CONEXIONES DE ANTENA/CABLE

Consulte la figura 4 de la página 10

Nota para el instalador de sistemas CATV

Esta nota tiene la finalidad de llamar la atención del instalador de sistemas CATV para que tenga en cuenta el Artículo 820-40 del NEC, el cual proporciona consejos para hacer una conexión a tierra apropiada y, en particular, especifica que la tierra del cable deberá estar conectada al sistema de puesta a tierra del edificio, tan cerca del punto de entrada del cable como sea posible.

NOTA:

Antes de enchufar la antena a la toma ANT.IN del televisor/DVD, compruebe que la clavija no esté doblada. Si esta doblada, póngala derecha como se muestra en la ilustración, y luego conéctela en la toma ANT.IN del televisor/DVD.

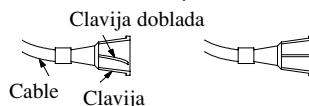

(Necesita enderezarse) (Clavija derecha)

ANTENA COMBINADA DE VHF/UHF

La antena combinada de VHF/UHF de 75 ohmios puede conectarse al terminal ANT.

ANTENA SEPARADAS DE VHF/UHF

En algunas zonas será necesario utilizar una antena exterior.

TELEVISION POR CABLE SIN CAJA DE CONVERTIDOR / DECODIFICADOR

Utilice esta conexión si su sistema de televisión por cable se conecta directamente a su televisor/DVD sin una caja de convertidor. Utilice el mando a distancia del televisor/DVD para seleccionar los canales.

TELEVISION POR CABLE CON CAJA DE CONVERTIDOR/DECODIFICADOR O CAJA DE SATRLITE

Si su compañía de televisión por cable le suministra una caja de convertidor, o si usted utiliza un sistema de satélite, usted podrá utilizar la conexión básica mostrada aquí.

La selección de los canales deberá hacerse con la caja de convertidor o con la caja de satélite. Esto significa que los canales no se podrán cambiar utilizando el mando a distancia del televisor/DVD.

PARA VER UN CANAL CODIFICADO/DECODIFICADO

- 1) Ponga el selector de canales del televisor/DVD en la posición del canal de salida de la caja de convertidor de televisión por cable o de la caja de satélite. (Ej., CH3)
- 2) Seleccione el canal que va a ver en su caja de convertidor de televisión por cable o caja de satélite.

CONEXIÓN A TOMAS DE ENTRADA EXTERNA

Cuando vea un programa grabado en otra fuente (videgrabadora o videocámara), utilice las tomas de entrada de audio/vídeo de la parte delantera del televisor/DVD.

Conecte las tomas de salida de audio/vídeo de otra fuente a las tomas AUDIO L/R y VIDEO de este televisor/DVD. Luego pulse SELECT hasta que aparezca "AUX" en la pantalla.

NOTA:

- Cuando conecte una videgrabadora monofónica (otra fuente) a este televisor/DVD, conecte la toma de salida de audio de la videgrabadora monofónica (otra fuente) a la toma AUDIO L de este televisor/DVD. El audio saldrá igualmente por los canales izquierdo y derecho.

Consulte la figura 5 de la página 11

CONEXIÓN A UN AMPLIFICADOR EQUIPADO CON TOMAS DE ENTRADA DIGITAL, PLATINA MD O PLATINA DAT (Para DVD)

Utilice un cable digital coaxial de audio de venta en el comercio especializado para hacer las conexiones de audio.

Consulte la figura 6 de la página 11

NOTAS:

- La fuente de audio de un disco en un formato de sonido ambiental Dolby Digital de 5,1 canales no se puede grabar como sonido digital mediante una platina MD o DAT.
- Asegúrese de desconectar la alimentación de todos los componentes antes de conectar otro componente.
- Consulte los manuales del propietario de los componentes que va a conectar al televisor/DVD.
- Ponga DOLBY DIGITAL en OFF para la salida de audio en el modo de preparación. La reproducción en un televisor/DVD utilizando ajustes incorrectos puede causar distorsión de ruido, y también se pueden dañar los altavoces. (Consulte la página 28 para poner DOLBY DIGITAL en OFF.)

CONEXIONA UN DECODIFICADOR DOLBY DIGITAL (Para DVD)

Si utiliza este televisor/DVD para reproducir un disco DVD en un formato de sonido ambiental Dolby Digital de 5,1 canales, el televisor/DVD dará salida a un flujo de datos DOLBY DIGITAL desde su toma de salida de audio digital COAXIAL. Conectando el reproductor a un decodificador Dolby Digital, usted podrá disfrutar de un ambiente más convincente y real, con un sonido ambiental potente y de alta calidad similar al de los cines.

Utilice cables digitales coaxiales de audio disponibles en el comercio especializado para hacer las conexiones de audio.

Consulte la figura 7 de la página 12

NOTAS:

- Asegúrese de desconectar la alimentación de todos los componentes del sistema antes de conectar a otro componente.
- Consulte los manuales del propietario de los componentes que vaya a conectar al televisor/DVD.
- Si conecta un decodificador Dolby Digital, ponga DOLBY DIGITAL en ON para la salida de audio en el modo de preparación. (Consulte la página 28 para poner DOLBY DIGITAL en ON.)
- A menos que se haga la conexión a un decodificador Dolby Digital, ponga DOLBY DIGITAL en OFF para la salida de audio en el modo de preparación. La reproducción en el televisor/DVD utilizando ajustes incorrectos puede generar distorsión de ruido, y también puede estropear los altavoces.

Fabricado bajo licencia de Dolby Laboratories. "Dolby" y el símbolo de la D doble son marcas de fábrica de Dolby Laboratories.

TV SECTION

PREPARACIÓN PARA LA UTILIZACIÓN

SELECCIÓN DE IDIOMA

TV

1 Enchufe el cordón de alimentación del televisor/DVD

Enchufe el cordón de alimentación del televisor/DVD en una toma de CA estándar.

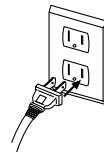

NOTA:

- Si aparecen algunas cifras en la esquina de la pantalla, pulse el botón POWER sin desenchufar el cordón de alimentación.

Asegúrese de que ...

- Pulse el botón POWER para encender el televisor/DVD.

NOTA: Esta función afecta sólo el idioma en el menú de la pantalla y no la fuente de audio.

2 Seleccione "LANGUAGE"

Pulse el botón SETUP en el mando a distancia.

Pulse el botón ▲ o ▼ para señalar "LANGUAGE".

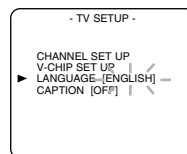

3 Seleccione "ENGLISH", "ESPAÑOL" o "FRANÇAIS"

Seleccione "ENGLISH", "ESPAÑOL" o "FRANÇAIS" con el botón ENTER.

4 Salga del modo de idioma

Pulse el botón SETUP en el mando a distancia para volver al modo del televisor.

NOTA: Si, por alguna razón, el menú está en español o francés, pulse el botón SETUP en el mando a distancia, pulse el botón ▲ o ▼ para señalar el "IDIOMA (ESPAÑOL)" o "LANGAGE (FRANÇAIS)", a continuación, pulse el botón ENTER y pulse el botón SETUP en el mando a distancia.

AJUSTE DE CANAL

TV

Puede programar el sintonizador para buscar todos los canales que recibe en su localidad.

NOTA: El canal preparado NO es necesario cuando esté conectado a una caja de cable o caja de satélite. Sólo tiene que seleccionar con el selector de canal del televisor/videograbadora al canal de salida de la caja de cable o caja de satélite (por ejemplo el canal CH3). Seleccione el canal a ver en la caja de cable o caja de satélite.

Asegúrese de que ...

- Pulse el botón POWER para encender el televisor/DVD.

1 Seleccione "AJUSTE DE CANAL"

Pulse el botón SETUP en el mando a distancia.

Pulse el botón ▲ o ▼ para señalar "AJUSTE DE CANAL".

A continuación, pulse el botón ENTER.

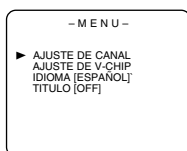

2 Empiece el prefijado automático

Pulse el botón ▲ o ▼ para señalar "AUTOPROGRAMACION DE CA".

A continuación, pulse el botón ENTER.

El sintonizador busca y memoriza todos los canales activos en su localidad.

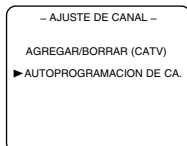

3 Después de buscar

El sintonizador se detiene en el canal memorizado más bajo.

- Cuando se activa AUTOPROGRAMACION DE CA, donde no hay entrada de señal del televisor, aparecerá "NO HAY SEÑAL DE TV" en la pantalla después de terminar la búsqueda de canales.
- El televisor/DVD puede reconocer los canales de TV para que sean canales de TV de antena de cable con las condiciones de recepción. En este caso, pruebe nuevamente con el prefijado automático en las condiciones de recepción fina.

DVD SECTION

REPRODUCCIÓN DE UN DVD DE VÍDEO O UN CD DE AUDIO

REPRODUCCION BASICA

DVD-V CD MP3

Para empezar

- Conecte el interruptor del amplificador y otros equipos, si fuera necesario.

1 Pulse el botón POWER.

- La alimentación se conectará.

2 Pulse el botón OPEN/CLOSE.

- La bandeja de carga del disco se abrirá.

3 Ponga el disco en la bandeja con el lado de la etiqueta hacia arriba.

4 Pulse el botón PLAY.

- La bandeja se cerrará automáticamente y la reproducción empezará luego desde el primer capítulo o pista del disco. Si la reproducción no empieza automáticamente, pulse PLAY.
- Cuando reproduzca un DVD que tenga grabado un menú de títulos, el menú aparecerá en la pantalla.

5 Pulse el botón STOP para detener la reproducción.

MEMO

SYLVANIA

LIMITED WARRANTY

FUNAI CORP. will repair this SYLVANIA product, free of charge in the USA in the event of defect in materials or workmanship as follows:

DURATION:

PARTS: FUNAI CORP. will provide parts to replace defective parts without charge for one (1) year from the date of original retail purchase. Two (2) years for Picture Tube. Certain parts are excluded from this warranty.

LABOR: FUNAI CORP. will provide the labor without charge for a period of ninety (90) days from the date of original retail purchase.

LIMITS AND EXCLUSIONS:

This warranty is extended only to the original retail purchaser. A purchase receipt or other proof of original retail purchase will be required together with the product to obtain service under this warranty.

This warranty shall not be extended to any other person or transferee.

This warranty is void and of no effect if any serial numbers on the product are altered, replaced, defaced, missing or if service was attempted by an unauthorized service center. This SYLVANIA Limited warranty does not apply to any product not purchased and used in the United States.

This warranty only covers failures due to defects in material or workmanship which occurs during normal use. It does not cover damage which occurs in shipment, or failures which are caused by repairs, alterations or product not supplied by FUNAI CORP., or damage which results from accident, misuse, abuse, mishandling, misapplication, alteration, faulty installation, improper maintenance, commercial use such as hotel, rental or office use of this product or damage which results from fire, flood, lightning or other acts of God.

THIS WARRANTY DOES NOT COVER PACKING MATERIALS, ANY ACCESSORIES (EXCEPT REMOTE CONTROL), ANY COSMETIC PARTS, COMPLETE ASSEMBLY PARTS, DEMO OR FLOOR MODELS.

FUNAI CORP. AND ITS REPRESENTATIVES OR AGENTS SHALL IN NO EVENT BE LIABLE FOR ANY GENERAL, INDIRECT OR CONSEQUENTIAL DAMAGES ARISING OUT OF OR OCCASIONED BY THE USE OF OR THE INABILITY TO USE THIS PRODUCT. THIS WARRANTY IS MADE IN LIEU OF ALL OTHER WARRANTIES, EXPRESS OR IMPLIED, AND OF ALL OTHER LIABILITIES ON THE PART OF FUNAI, ALL OTHER WARRANTIES INCLUDING THE WARRANTY OF MERCHANTABILITY, AND FITNESS FOR A PARTICULAR PURPOSE, ARE HEREBY DISCLAIMED BY FUNAI AND ITS REPRESENTATIVES IN THE UNITED STATES. ALL WARRANTY INSPECTIONS AND REPAIRS MUST BE PERFORMED BY A FUNAI AUTHORIZED SERVICE CENTER. THIS WARRANTY IS VALID WHEN THE UNIT IS CARRIED-IN TO FUNAI AUTHORIZED SERVICE FACILITY.

IMPORTANT:

THIS LIMITED WARRANTY GIVES YOU SPECIFIC LEGAL RIGHTS, YOU MAY HAVE OTHER RIGHTS THAT VARY FROM STATE TO STATE, IF, AT ANY TIME DURING THE WARRANTY PERIOD, YOU ARE UNABLE TO OBTAIN SATISFACTION WITH THE REPAIR OF THIS PRODUCT, PLEASE CONTACT FUNAI CORP.

ATTENTION:

FUNAI CORP. RESERVES THE RIGHT TO MODIFY ANY DESIGN OF THIS PRODUCT WITHOUT PRIOR NOTICE.

To locate your nearest SYLVANIA Authorized Service Center or for general service procedure, please call 1-800-968-3429 or write to the following:

**FUNAI CORPORATION, INC.
SERVICE CENTER**

19900 Van Ness Avenue, Torrance, CA 90501

Tel :1-800-968-3429
<http://www.funai-corp.com>

Head Office: 100 North Street, Teterboro, NJ 07608

PLEASE DO NOT SHIP YOUR UNIT TO THE TETERBORO ADDRESS.